

VACUUM LIFTERS

PRODUCT PROGRAM VACUHAND EASYHAND

Vacuum lifters lift your production

Vacuhand and Easyhand constitute a series of vacuum lifters, which in different versions have been a part of Movomech's range for decades.

Movomech is now presenting the next generation of vacuum lifters for ergonomic and efficient material handling.



Movomech AB

Movomech AB develops and manufactures a wide range of ergonomic lifting devices for the industry – from a first class lightweight overhead crane system in aluminium to complete turnkey solutions with advanced lifting manipulators and tailor-made gripper tools.

Movomech's head office and production facilities are located in Kristianstad in southern Sweden, with global representation via sales offices and distributors throughout the world.

Movomech AB is certified according to ISO 9001 and ISO 14001. Minimal environmental impact is a key part all manufacturing and forms part of the strategic work.

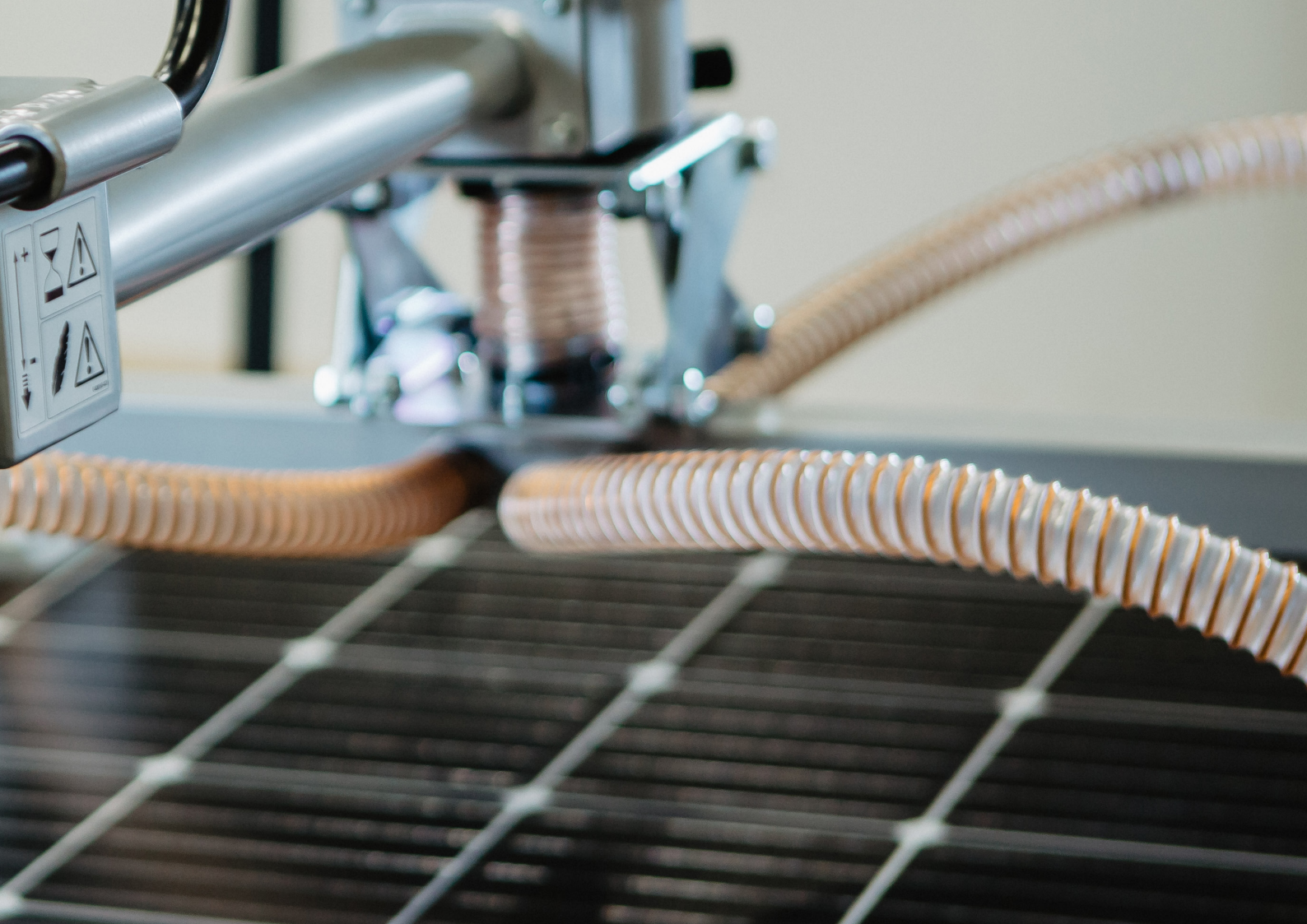

Handling solutions for a healthy work environment!

Movomech's ergonomic material handling solutions contribute to healthier workplaces in industrial environments. By preventing musculoskeletal disorders, the chances for employees to thrive and for an efficient production increase.



Contents

Safe lifting with vacuum	4
Common applications.....	6
Product program	9
EASYHAND PRO RAPID™	10
EASYHAND PRO™	12
EASYHAND M™	14
VACUHAND PRO™	16
Guidelines for configuration	18
Overhead crane system	22
Jib cranes	24
EASYCRANE™	26

Safe lifting with vacuum

For many different sectors

Vacuum tube lifters are smooth and easy-to-use lifting manipulators that perform efficient lifting operations, for e.g. in logistics and distribution, mechanical engineering, glass and furniture production.

The load is lifted and held with negative pressure in the lifting tube, which is operated by the vacuum lifter's operating handle.

Intuitive control

A major advantage of vacuum lifters is their intuitive control, which minimises the personnel's learning and start-up time to reach full production speed.

Ergonomics is economic

Vacuum lifters enable the load to be handled more quickly and safely while the personnel are spared from heavy and uncomfortable lifting movements. A benefit for both personnel and production!

Delivers complete system solutions

Movomech's expertise is complete system solutions. The vacuum lifter, with carefully chosen accessories, is mounted together with a jib crane or on a traverse system, thus constituting a complete workstation for ergonomic material handling.

Avoid working above shoulder height

It is important to avoid working with your hands and arms above shoulder height.

With outstretched or raised arms, blood pressure increases in a sensitive muscle of the shoulder, which can restrict the blood circulation in the area and cause damage and pain ("impingement syndrome").



Vacuum lifting is suitable for many products

Many different types of goods and packaging can be handled efficiently with a vacuum lifter and the right lifting equipment. Materials such as wood, glass, stone, metal, cardboard, paper and plastic can be safely and neatly lifted with a vacuum without marking the surface.





Ergonomics, efficiency and safety

The vacuum lifting program Easyhand and Vacuhand has been developed to facilitate lifting work with a focus on great lifting ergonomics, in combination with an efficient and safe production.

Weightlessness gives flexibility

Lifting devices make it easy to lift heavy objects without demanding physical strength.

The fact that all the personnel, regardless of their circumstances, can perform lifting work, increases production flexibility.



How much are you allowed you lift?

The Swedish Work Environment Authority's regulations regarding ergonomics for the prevention of musculoskeletal disorders AFS 2012:2 describes how work must be planned and performed in order to prevent strain problems. How far away from the lumbar region the lifting is carried out plays a role when lifting in ideal conditions is assessed based on a simple assessment model.

In most cases, 25 kg is unsuitable to handle manually, but even the lifting of weights from 4-5 kg can cause problems.

In a more careful assessment of a lifting activity, many more influencing factors must be taken into account, such as how often the object must be lifted, if the lifting is performed with a bent back or above shoulder height.

For more information, contact Movomech AB, or visit the Swedish Work Environment Authority's website.



As represented in AFS 2012:2 (www.amv.se)

Common applications

Lifting bags and sacks

Not only are bags often heavy and made of a difficult-to-grip material, but their shape and solidity can vary, and the centre of gravity shifts during handling, which increases the physical strain on the personnel.

Lifting devices in the form of a vacuum lifter with a suction cup for bags can often provide effortless bag handling that is both ergonomic and efficient. Lifting operations are performed neatly and safely, without damage to the bag or its contents – an important condition for a safe and stable production.



A bag lifter spares the back — Lifting heavy bags and sacks with a bent or twisted back results in an increased risk of musculoskeletal disorders. Lifting devices are often a good solution to avoid musculoskeletal disorders among the personnel when the work cannot be reorganised or automated.

To consider when choosing a vacuum lifter for bag handling:

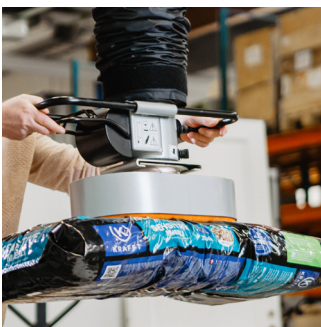

The bags material's wear resistance is of importance. Check that the packaging can hold the weight of the contents without the risk of splitting open.



There is a great difference between lifting bags of non-porous and porous materials. The more porous the bag, the greater the vacuum flow required.

Porous bags are made of paper or fabric, while non-porous bags are often made of plastic.



If the bag is loosely packed, the bag suction pad is fitted with a separation grid inside to prevent the bag from being sucked into the suction pad.



Movomech recommends careful testing with combinations of suction power, gripper equipment and operating handles for the best results.

Lifting cardboard boxes

The lifting of parcels and cardboard boxes is one of the most common lifting operations in the industry, which can cause muscle pain among the personnel if the work spans over a long time, with high repetitivity, in tight spaces or with a heavy load.

Choosing the right lifting device for the lifting of cardboard boxes is important to ensure safe, effortless and efficient material handling with optimal ergonomics.

In Movomech's product program for vacuum lifters, there are many options that suit precisely your handling operation, no matter if it involves the stacking of boxes or the fast and efficient handling of smaller cardboard boxes at packing stations.



Lifting devices for efficient material handling — Choosing the right lifting device for crates and cardboard boxes is important to ensure safe, effortless and efficient material handling with optimal ergonomics.

To consider when choosing a vacuum lifter for cardboard box handling:



The cardboard box's material and its closure (with tape, staples or strapping) is important for how its surface can be gripped: with a suction cup or a yoke.

The bottom of the box needs to be securely closed to hold under the weight of the contents.



If different batches of porous and non-porous cardboard boxes are to be handled by the same vacuum lifter, it is useful if the vacuum flow and lifting capacity can be easily adjusted with easily-accessed controls.



When stacking cardboard boxes repeatedly, it is important to avoid lifting your hands or arms above shoulder height.

In such cases, an extended and articulated handle can offer an improved working position.

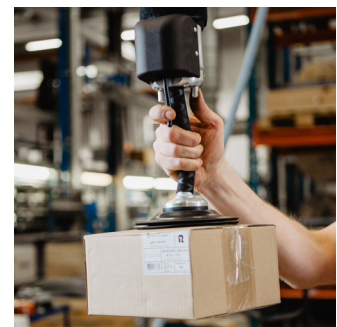

When a high tempo is required for loading packets and cardboard boxes, it may be practical to have a quick release function for fast and efficient handling.

Lifting panels, sheet metal and glass

The handling of sheet materials such as flat glass, sheet metal and chipboard is one of the most common lifting operations that is performed daily in our workplaces.

Handling sheet materials manually is often both heavy and cumbersome, and can cause musculoskeletal disorders and long-term sick leave.

When several sheet materials are stacked horizontally or vertically, the sheet's top face is often the only accessible surface to grip and handle the product, which makes the vacuum yoke one of the best adapted lifting devices.



Increased efficiency with vacuum lifters — With the help of lifting devices, cumbersome sheet materials can often be handled easily and effortlessly by one person instead of two! A remarkable difference to the workstation's productivity and an easy way to release resources.

To consider when choosing a vacuum lifter for panel handling:



At processing machines, it is often a good idea to have an extra hand when handling heavy and cumbersome sheet materials.

A vacuum lifter is a valuable aid in order to reduce physical strain and facilitate handling.



There is a great difference between lifting porous construction boards compared to non-porous objects like sheet metal and glass.

If the material is porous, the combination of suction power and gripper equipment should be carefully tested to produce the optimal vacuum lifter configuration.



Lifting the most is not always best.

Each lifting configuration is checked against a safety factor of at least 2.5 times between the area of the suction pad and the lifter tube.

If the safety factor is too high, it can be difficult to release the lifted object. A release valve may sometimes be needed.

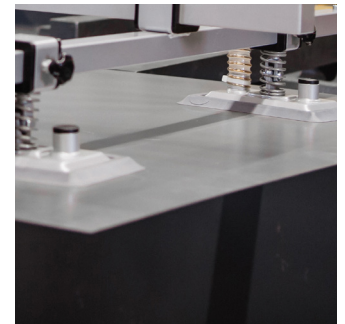

Sheet metal and sheet materials that are handled with vacuum lifters must be dry and free of oil and dirt.

Product program

Complete vacuum lifting program

Movomech's vacuum lifting program consists of two product families, Vacuhand and Easyhand, with a total of four products. Each product has unique features and ancillary accessories for perfect adaption to each handling operation.

Modular range

A great benefit of the product program is its modularity; many of the accessories are adapted to several of the lifting units, which makes it easy to create flexible workstations with a series of different lifters.



	Easyhand Pro Rapid™	Easyhand Pro™	Easyhand M™	Vacuhand Pro™
Max. load [kg]	35	50	50	250
Grip	Single-handed grip with ergonomically designed handle	Single-handed grip with ergonomically designed handle	Short or extended single-handed grip	Two-handed / single-handed grip
Tube diameter [mm]	80 / 100 / 120	60 / 80 / 100 / 120	60 / 80 / 100 / 120	140 / 160 / 180 / 200 230 / 250 / 300
Noise level [dB(A)]	62-72 / 52-62 ¹ ¹ With silencing box	62-72 / 52-62 ¹	62-72 / 52-62 ¹	75-86 / 68-74 ¹
Accessories	With suction cup for cardboard box handling Angle joint, swivel, angle joint with swivel, remote control etc.	Several suction pads and vacuum yokes Angle joint, swivel, angle joint with swivel, remote control etc.	Extended handles, articulated extended handles Broad program of suction pads and vacuum yokes Angle joint, swivel, remote control etc.	Extended handles, articulated extended handles Broad program of suction pads and vacuum yokes Angle joint, swivel, remote control etc.
Control	The unit with load rises, the engaged controller lowers the load With quick release function for releasing the load onto the drop-off surface	When the controller is engaged, the load is lifted	When the controller is engaged, the load is lifted	When the controller is engaged, the load is lifted
Vacuum source	Electric vacuum pump or pneumatic ejector	Electric vacuum pump or pneumatic ejector	Electric vacuum pump or pneumatic ejector	Electric vacuum pump
Objects	For specific application: fast cardboard box handling at workstations in logistics and distribution	For different types of handled objects: cardboard boxes, sheet materials, smaller bags etc.	For different types of handled objects: cardboard boxes, sheet materials, smaller bags etc.	For different types of handled objects: cardboard boxes, sheet materials, bags etc.

EASYHAND PRO RAPID™

Easyhand Pro Rapid™ is a very fast vacuum lifter with a single-handed grip, designed for applications that require fast handling of cardboard boxes and packaging. Its main application is cardboard box handling at workstations in logistics and distribution.

Easyhand Pro Rapid™ is equipped with a quick release function to enable quick release of the lifted object above its drop-off area.

The lifter is available in several versions, from simple straight lifting with suction cups in standard versions to versions with swivel and a 90° tilt function.

With controls on the operating handle, it is easy to adjust the lifter's stand-by height without a load.



LIFTING UNIT		80	100	120
Lifting tube ø	[mm]	80	100	120
Max. capacity ¹	[kg]	25	30	35
Lifting tube L	[mm]	2500 / 4000 option		
Min. lifting stroke Z	[mm]	approx. 1700 / 3000 option		

¹ The lifting capacity depends on the combination of the lifter tube, suction pad and handled object's porosity, see p. 18.

PUMP		A	B	C	D	K	I
Type		Pneu.	Pneu.	Elec.	Elec.	Elec.	Elec.
Output	[kW]	-	-	0,75	1,3	1,5	2,6
Max. flow	[l _n /min]	400	600	410	660	1000	1500
Flow level		I	I-II	I	I-II	II-III	II-III
Noise level	[dB(A)]	69	72	62	67	70	72
Noise level (with cover)	[dB(A)]	-	-	52	57	60	68

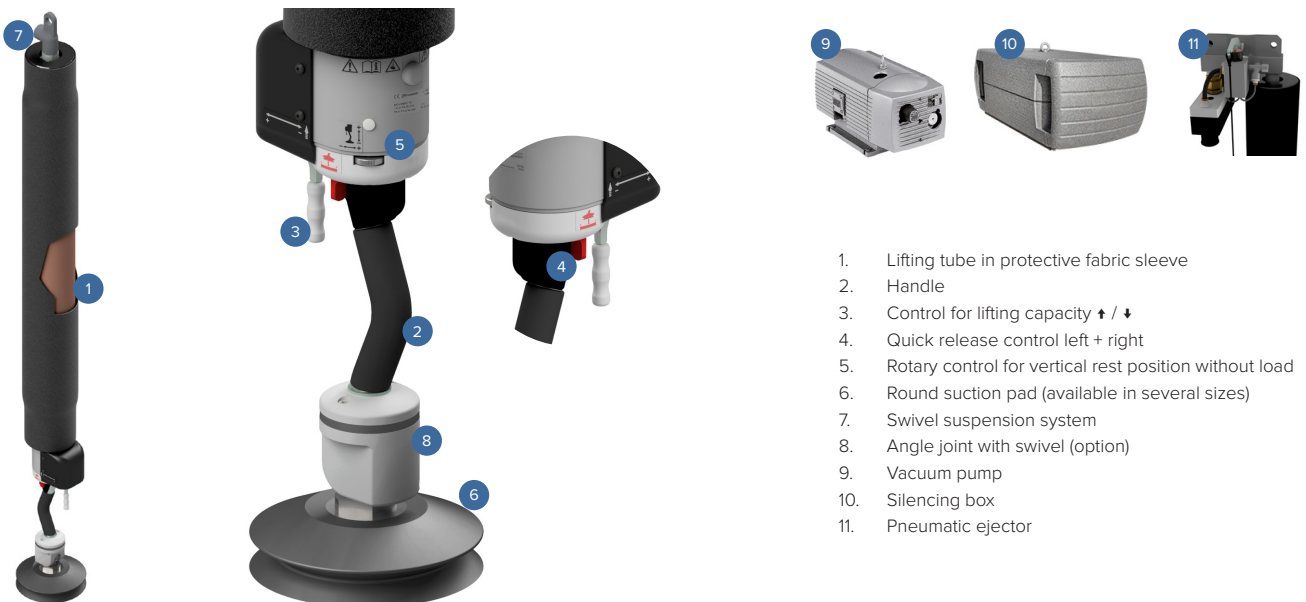

1. Lifting tube in protective fabric sleeve
2. Handle
3. Control for lifting capacity ↑ / ↓
4. Quick release control left + right
5. Rotary control for vertical rest position without load
6. Round suction pad (available in several sizes)
7. Swivel suspension system
8. Angle joint with swivel (option)
9. Vacuum pump
10. Silencing box
11. Pneumatic ejector



Easyhand Pro Rapid™ – our vacuum lifter for easy and efficient parcel handling in logistic centres.

- ✓ Very fast vacuum lifter with single-handed grip
- ✓ For logistics and distribution centres
- ✓ Lifts cardboard boxes and packaging up to 35 kg
- ✓ For efficient and fast material handling
- ✓ With quick release function



A selection of standard accessories



Bellows suction cup
ø150, ø200



90° angle joint with swivel



Mini yoke with 2 suction pads



Baggage suction pad

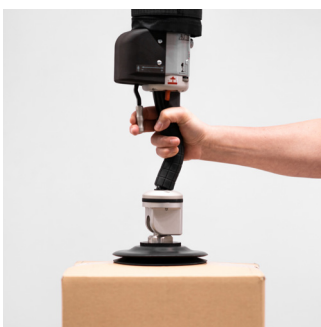

The object is automatically gripped when the suction pad is placed on its surface.



With an angle joint, the object can also be gripped from the side.

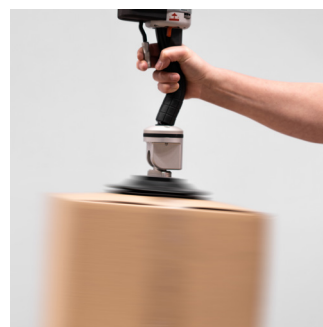

A swivel allows the object to be freely rotated.



Controlled release of the object onto the drop-off area.

EASYHAND PRO™

Easyhand Pro™ is an effortless and comfortable vacuum lifter with a single-handed grip for the handling of loads up to 50 kg. The lifter's main strength is its smooth operation and lifting feel.

The lifting and lowering function is adjusted with an ergonomically designed control handle. By means of controls on the operating handle, it is easy to adjust the lifter's stand-by height with or without a gripped load.

With a large range of suction cups and vacuum yokes, the lifter can easily be adapted to any needs and requirements.



LIFTING UNIT		60	80	100	120
Lifting tube ø	[mm]	60	80	100	120
Max. capacity ¹	[kg]	25	35	45	50
Lifting tube L	[mm]	2500 / 4000 option			
Min. lifting stroke Z	[mm]	approx. 1700 / 3000 option			

¹ The lifting capacity depends on a combination of lifting tube, suction pad and the handled object's porosity, see p. 18.

PUMP		A	B	C	D	K	I
Type		Pneu.	Pneu.	Elec.	Elec.	Elec.	Elec.
Output	[kW]	-	-	0,75	1,3	1,5	2,6
Max. flow	[l _n /min]	400	600	410	660	1000	1500
Flow level		I	I-II	I	I-II	II-III	II-III
Noise level	[dB(A)]	69	72	62	67	70	72
Noise level (with cover)	[dB(A)]	-	-	52	57	60	68

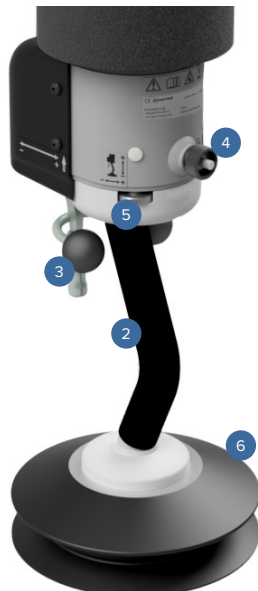

1. Lifting tube in protective fabric sleeve
2. Handle
3. Control for lifting capacity ↑ / ↓ release load
4. Rotary control for vertical rest position with load
5. Rotary control for vertical rest position without load
6. Round suction pad (available in several versions)
7. Suction pad yoke (available in several versions)
8. Swivel suspension system
9. Vacuum pump
10. Silencing box
11. Pneumatic ejector

Easyhand Pro™ – an effortless and comfortable vacuum lifter for the handling of loads up to 50 kg.

- ✓ Effortless vacuum lifter with single-handed grip
- ✓ Intuitive lifting feel
- ✓ Easy to adjust for each handling operation
- ✓ Versatile and modular
- ✓ For comfortable and ergonomic material handling



A selection of standard accessories



Bellows suction cup
ø150, ø200



90° angle joint with swivel



Fixed mini yoke with 2 suction pads



Mini yoke with 2 suction pads



Single suction pad
□ 200x290, 125x320, 140x200



Fixed yoke with 2 suction pads
300, 500, 800, 1000
□ 2x 85x200



Yoke with 2 suction pads
500, 800, 1200
□ 2x 120x210, 120x315, 200x290



Fixed yoke with 4 bellows suction cups
ø75: 190x230, 185x325, 235x325
ø110: 280x370, 330x500
ø150: 350x350



Remote control



Quick release device



90° angle joint



Bottom swivel
Freely-rotating
Freely-rotating dual layered (for tilt)
Freely-rotating 4-position

EASYHAND M™

Easyhand M™ is a flexible vacuum lifter with a modular design for loads of up to 50 kg. It makes it easy and comfortable to handle anything from bags and cardboard boxes to sheet materials such as glass and panels.

The operating handle comes in two versions, a straight handle for control above the lifted object, and an extended handle for control at a distance from the load.

With controls on the operating handle, it is easy to adjust the lifter's stand-by height with or without a gripped load.

Correctly set balancing also provides a possibility to release the operating handle, and with both hands manipulate the load and the Easyhand M™ laterally.



LIFTING UNIT		60	80	100	120
Lifting tube ø	[mm]	60	80	100	120
Max. capacity ¹	[kg]	25	35	45	50
Lifting tube L	[mm]	2500 / 4000 option			
Min. lifting stroke Z	[mm]	approx. 1700 / 3000 option			

¹ The lifting capacity depends on a combination of lifting tube, suction pad and the handled object's porosity, see p. 18.

PUMP		A	B	C	D	K	I
Type		Pneu.	Pneu.	Elec.	Elec.	Elec.	Elec.
Output	[kW]	-	-	0,75	1,3	1,5	2,6
Max. flow	[l _n /min]	400	600	410	660	1000	1500
Flow level		I	I-II	I	I-II	II-III	II-III
Noise level	[dB(A)]	69	72	62	67	70	72
Noise level (with cover)	[dB(A)]	-	-	52	57	60	68

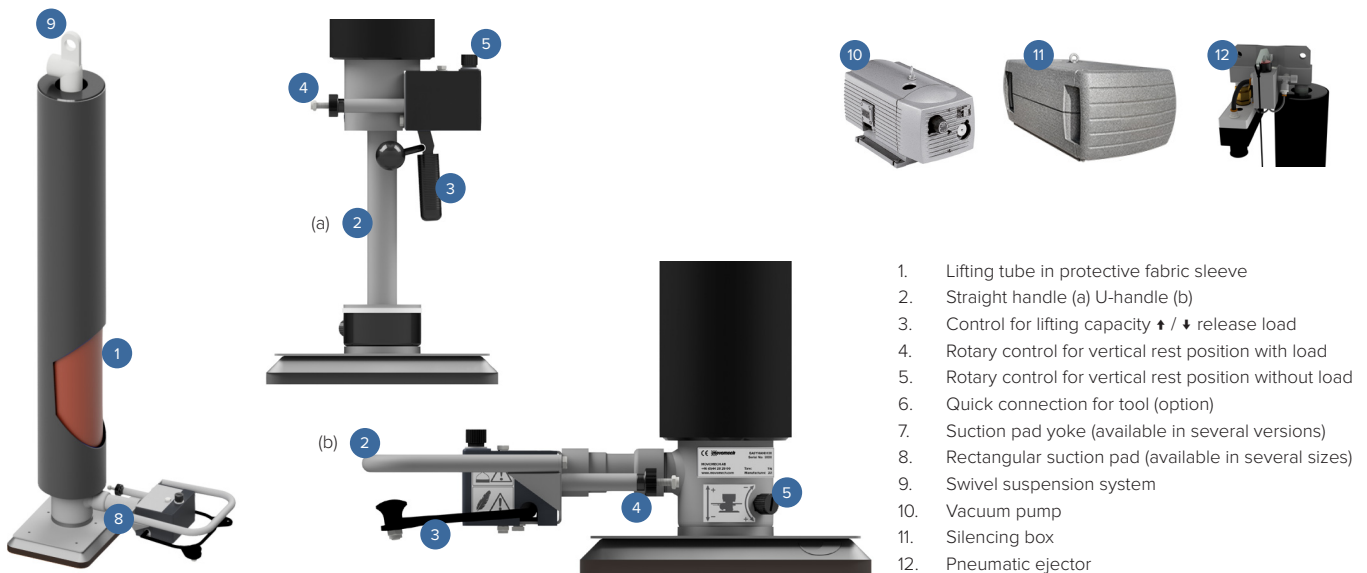

1. Lifting tube in protective fabric sleeve
2. Straight handle (a) U-handle (b)
3. Control for lifting capacity ↑ / ↓ release load
4. Rotary control for vertical rest position with load
5. Rotary control for vertical rest position without load
6. Quick connection for tool (option)
7. Suction pad yoke (available in several versions)
8. Rectangular suction pad (available in several sizes)
9. Swivel suspension system
10. Vacuum pump
11. Silencing box
12. Pneumatic ejector

Easyhand M™ provides flexible and operator-friendly material handling.

- ✓ Modular and adaptable lifter
- ✓ Large range of accessories
- ✓ Possibility to hold both hands on the load
- ✓ Handles easily bags, boxes and sheet materials
- ✓ Facilitates and streamlines lifting work



A selection of standard accessories



U-handle



Extended handle
200, 400, 600, 800, 1000



Extended articulated handle
200+200, 200+400, 200+600
400+400, 400+600
800+400



Extra handle grip
Straight
Straight with knob



Straight handle
Bellows suction cup: ø150, ø200
Single suction pad:
□ 200x290, 125x320, 140x200



Fixed yoke with 2 suction pads
300, 500, 800, 1000
□ 2x 85x200



Yoke with 2 suction pads
500, 800, 1200
□ 2x 120x210, 120x315, 200x290



Fixed yoke with 4 bellows suction cups
ø75: 190x230, 185x325, 235x325
ø110: 280x370, 330x500
ø150: 350x350

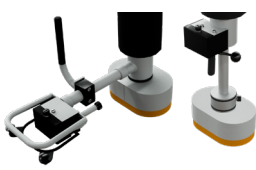

Bag suction pad
185x115, 290x154
275x175



Quick connection

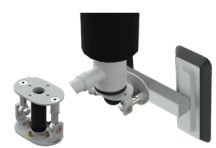

90° angle joint



Bottom swivel
Freely-rotating
Freely-rotating dual layered (for tilt)
Freely-rotating 4-position

VACUHAND PRO™

Vacuhand Pro™ is an efficient vacuum lifter with the capacity to lift up to 250 kg. The lifter is operated with an operating handle with a two-handed grip, and is used for light and efficient handling of bags, cardboard boxes and sheet materials.

Vacuhand Pro™ has a comprehensive range of utility programs with different versions for lifting units, power sources, accessories, and above all, different gripper equipment and special suction pads to handle lifted objects of different sizes and materials.

The control unit can be equipped with an articulated or fixed handle of different lengths as suited to each specific workplace.

The lifter's product series also includes a choice of control units and gripper equipment in stainless steel.



LIFTING UNIT		140	160	180	200	230	250	300
Lifting tube ø	[mm]	140	160	180	200	230	250	300
Max. capacity ¹	[kg]	90	110	130	145	175	200	250
Lifting tube L	[mm]	2500 / 4000 (option)						
Min. lifting stroke Z	[mm]	approx. 1700 / 3000 (option)						

¹ The lifting capacity depends on the combination of lifting tube, suction pad and the handled object's porosity, see p. 18.

PUMP		F	G	H
Output	[kW]	2,2	3,0	5,5
Max. flow	[l _n /min]	2360	3000	3920
Flow level ¹		I	I-II	II-III
Noise level	[dB(A)]	75	80	86
Noise level (with cover)	[dB(A)]	68	69	74

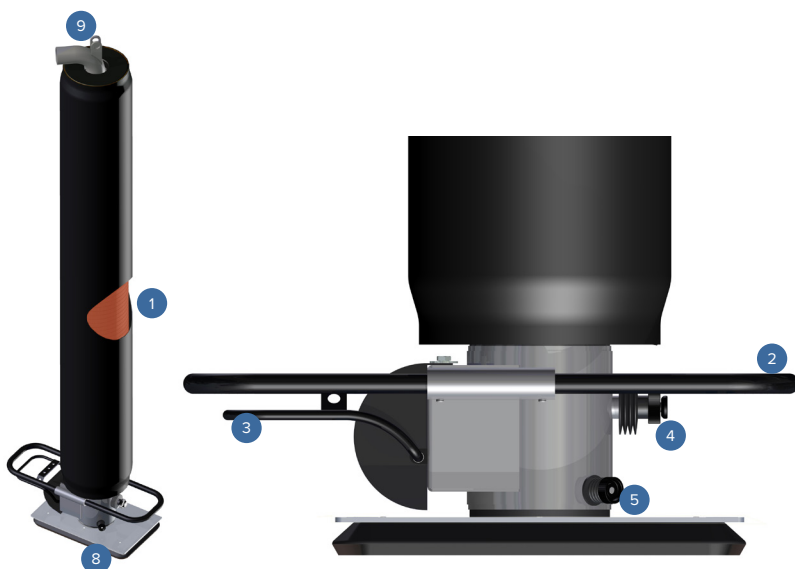

1. Lifting tube in protective fabric sleeve
2. Handle for two-handed hold
3. Control for lifting capacity ↑ / ↓ release load
4. Rotary control for vertical rest position with load
5. Rotary control for vertical rest position without load
6. Quick connection for tool (option)
7. Sack suction pad (available in several versions)
8. Rectangular suction pad (available in several sizes)
9. Swivel suspension system
10. Vacuum pump
11. Silencing box

For bag handling, Vacuhand Pro™ is the optimal choice thanks to the lifter's high performance.

- ✓ Modular universal lifter
- ✓ Impressive performance
- ✓ Provides safe and comfortable material handling
- ✓ Stable and operator-friendly design
- ✓ Minimise energy consumption with remote control



A selection of standard accessories

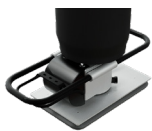

Fixed handle

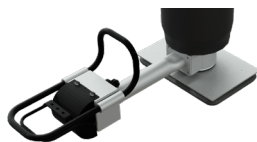

Fixed extended handle
200, 400, 600, 800, 1000



Extended articulated handle
200+200, 200+400, 200+600
400+400, 400+600
800+400



Quick connection



Single / Double suction pad
□ 200x290 / □ 2x200x290



Fixed yoke with 2 suction pads
500, 800, 1000
□ 2x 140x200



Yoke with 2 suction pads
500, 800, 1200
□ 2x 120x210, 120x315, 200x290



Yoke with 4 suction pads
500x600, 800x600, 1200x600
□ 4x 85x200, 120x315, 200x290



Round suction pad
ø230, ø250, ø280, ø300,
ø320, ø360, ø400



Bag suction pad
280x175, 375x210
455x260



90° angle joint
For fixed suction pads / yoke



Bottom swivel
Freely-rotating
Freely-rotating dual layered (for tilt)
Freely-rotating 4-position

Guidelines for configuration

Equipment adapted to lifted object

Equipment adapted to lifted object

When choosing a vacuum lifter for material handling, it is important to make a careful assessment of the object that is to be lifted.

Three important parameters:

- ✓ The object's weight
- ✓ The grip surface's shape and size
- ✓ The material's porosity

Non-porous or porous material?

For non-porous objects, the vacuum lifter can be configured with the help of capacity diagrams.

For porous materials, Movomech recommends careful testing with combinations of suction power, gripper equipment and operating handles.

For extremely porous materials, pneumatic or mechanical gripper equipment is recommended.

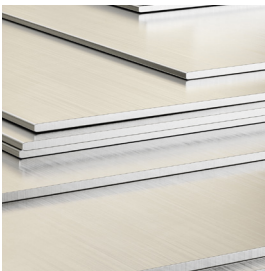

Flow level I - Non-porous surfaces

Examples: sheet materials of metal or plastic, metal barrels, glass panes

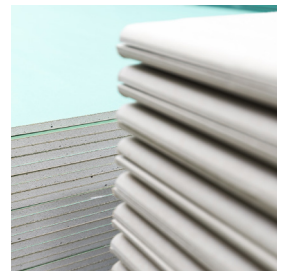

Flow level II - Porous surfaces

Examples: cardboard boxes, plastic packaging, wood products



Flow level III - Very porous surfaces

Examples: porous cardboard boxes, plastic or paper-based bags

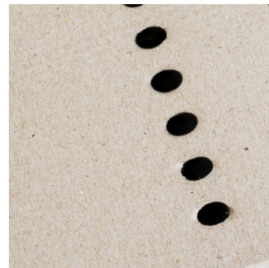

Flow level IV - Extremely porous surfaces ²

Examples: sacks and rolls of fabric, perforated materials

² Consider pneumatic-mechanical gripper tool

Choice of lifting tube

Based on the lifted object's weight, the appropriate lifting tube can be gauged from the diagram (pages 20-21). Take into account whether the lifted object is made of a non-porous or porous material.

Choice of suction pad

Choose the type of suction pad or vacuum yoke that suits the object. Check that the suction pad is of the right dimension in relation to the selected lifting tube size. The area of the suction pad must always be at least 2.5 times greater than the cross-sectional area of the lifting tube to avoid the load coming loose unintentionally.

In the case of a high safety factor, it can be more difficult to release the lifted object. (A release valve can be used to disengage the lifted object.)

When lifting an object that is tilted upwards 90°, use a multiplication factor of at least 4.0.

Safety factor calculation

The lifter tube's area:

$$\text{radius} \times \text{radius} \times 3.14 (\pi) = \text{area}$$

The suction pad's area, rectangular:

$$\text{length} \times \text{width} \times \text{number of suction pads} = \text{total area}$$

The suction pad's area, round:

$$\text{radius} \times \text{radius} \times 3.14 (\pi) \times \text{number of suction pads} = \text{total area}$$

$$\text{Safety factor} = \text{total area} / \text{area}$$

Example 1

Single rectangular suction pad 210x330 mm

$$\text{Lifter tube } \phi 140: 70 \times 70 \times 3.14 \times 1 = 15,386 \text{ mm}^2$$

$$\text{Suction pad: } 210 \times 330 = 69,300 \text{ mm}^2$$

$$69,300 / 15,386 = 4.50$$

Safety factor of 4.50 times which permitted with a good margin.

Example 2

Lifting yoke with 4 x round suction cups $\phi 150$ mm

$$\text{Lifter tube } \phi 160: 80 \times 80 \times 3.14 = 20,096 \text{ mm}^2$$

$$\text{Suction cup round } \phi 150: 75 \times 75 \times 3.14 = 17,662 \text{ mm}^2 \times 4 \text{ cups} = 70,648 \text{ mm}^2$$

$$70648 / 20,096 = 3.51$$

Safety factor of 3.51 times which permitted with a good margin.

Choice of vacuum pump

For non-porous materials, a pump/ejector with a lower flow can be chosen. For porous materials, a pump/ejector with a higher flow is required. Porous materials should always be tested to check functioning and lifting capacity.

Length of lifting tube

It is recommended that the suction pad is located at a height of approx. 100 mm above the floor surface when the lifting unit is installed.

When installing, if the suction pad is closer to the floor, the tube might need to be cut or the suspension system raised.

If the lifting tube is longer, and the suction pad can reach floor level, it is necessary to ensure that the suction pad is not able to attach itself to the floor on account of suction when the vacuum is activated.

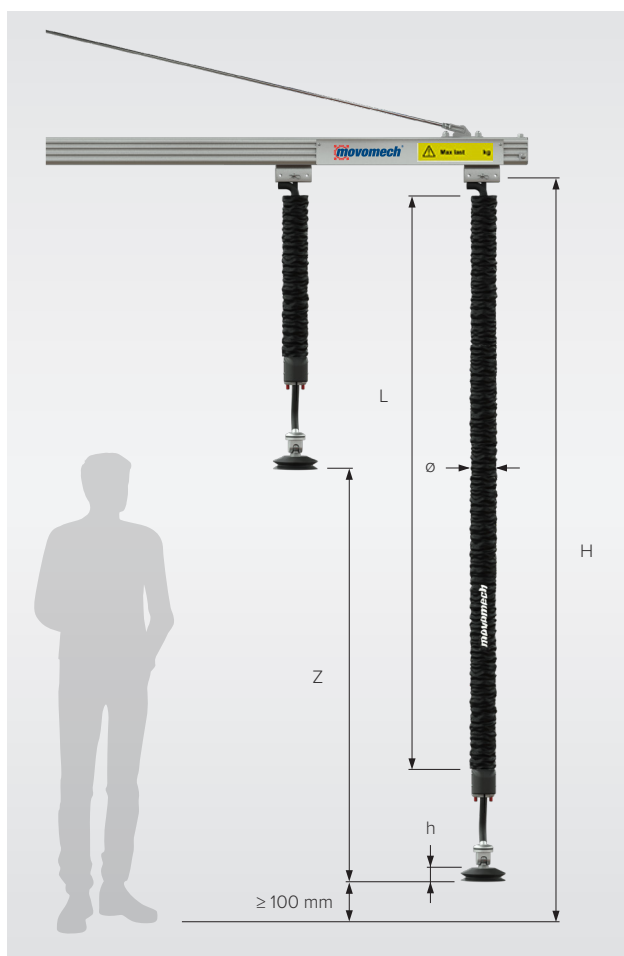

Z: lifting stroke (mm) H: standard installation height approx. 2,900 mm
 h: height of suction pad / lifting yoke (mm) approx. 50-120 mm
 ø: diameter of lifting tube (mm) L: length of lifting tube (mm)

Permitted load per tube diameter

The bars in the diagram show the recommended load capacity for flat, non-porous/porous materials that can be handled by a specific lifting unit.

The recommendations are based on appropriate lifting speeds. Light loads are lifted at higher speeds than heavy loads. Non-porous materials such as sheet metal is lifted more quickly than porous materials such as cardboard boxes.

Never use a combination of a lifting unit + pump for loads that are heavier than recommended.

In general, use the largest lifting tube diameter possible for a slow and smooth lifting movement. A narrow lifting tube diameter lifts quickly, but can also be felt to give a twitchier lifting sensation.

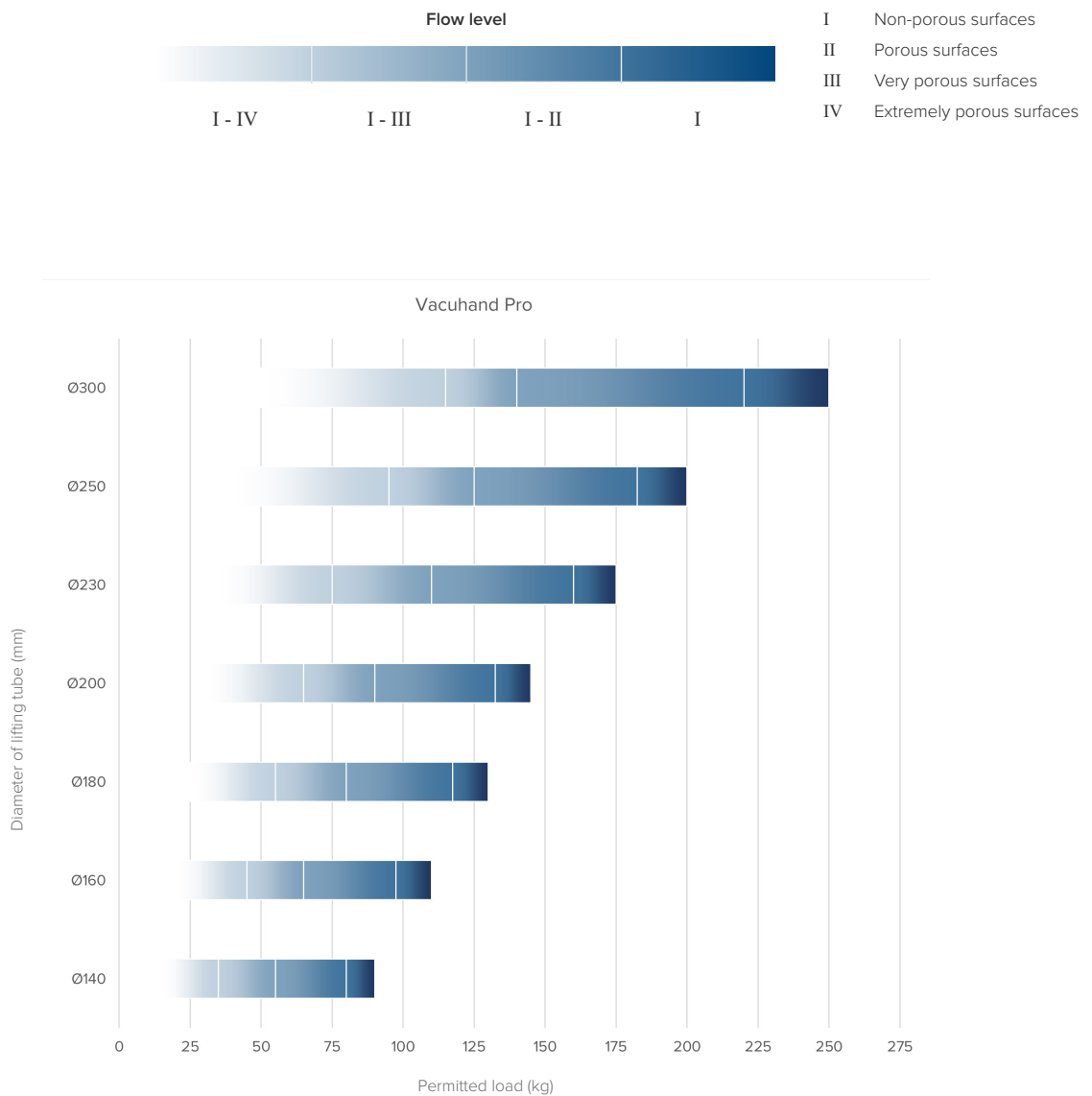

Examples

A Vacuhand Pro 160 with vacuum pump F is recommended for non-porous objects from approx. 50 kg to approx. 104 kg with a slow lifting speed.

A Vacuhand Pro 160 with vacuum pump G is recommended for non-porous objects from approx. 50 kg to approx. 104 kg with a faster lifting speed.

A Vacuhand Pro 160 with vacuum pump G is recommended (incl. test) for porous objects from approx. 40 kg to approx. 77 kg.

A Vacuhand Pro 160 with vacuum pump H is recommended (incl. test) for very porous objects from approx. 40 kg to approx. 77 kg.

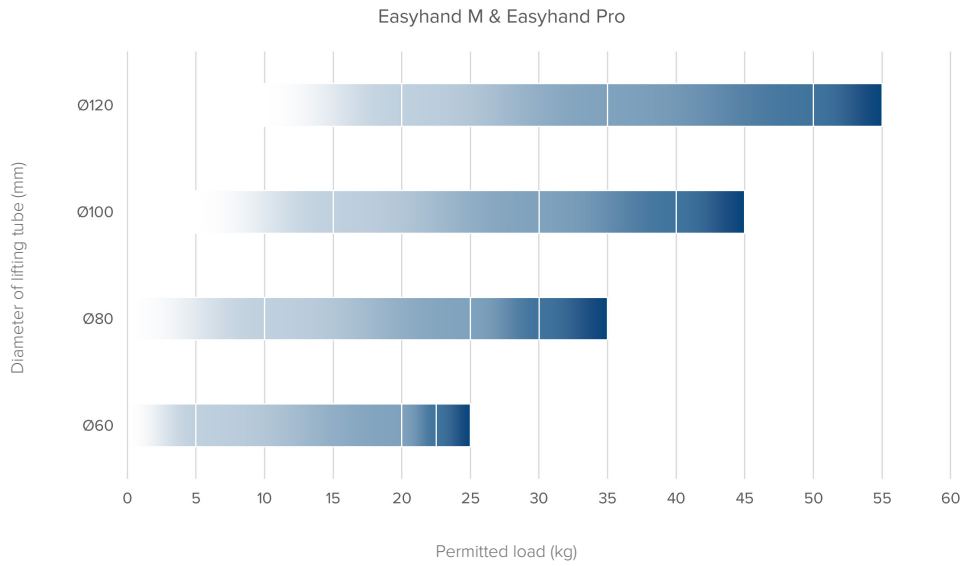

Examples

An Easyhand M 120 with vacuum pump C is recommended for non-porous objects from approx. 15 kg to approx. 55 kg with a slow lifting speed.

An Easyhand M 120 with vacuum pump D is recommended (incl. test) for porous objects from approx. 15 kg to approx. 40 kg.

An Easyhand M 120 with vacuum pump D is recommended for non-porous objects from approx. 15 kg to approx. 55 kg with a faster lifting speed.

An Easyhand M 120 with vacuum pump D is recommended (incl. test) for very porous objects from approx. 15 kg to approx. 40 kg.

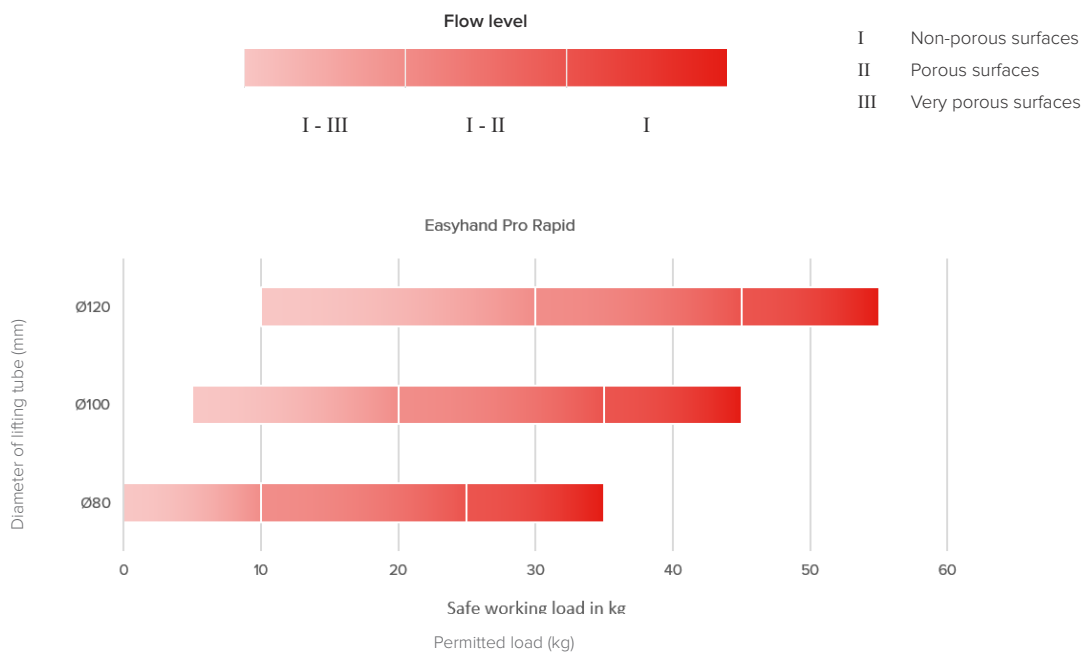

Please note that Easyhand Pro Rapid™ is designed for the specific application “fast cardboard box handling at workstations in logistics and distribution”. For other types of material handling, Easyhand Pro™ is recommended.

Examples

An Easyhand Pro Rapid 120 with vacuum pump C is recommended (incl. test) for cardboard boxes from approx. 20 kg to a max. of 35 kg with a normal lifting speed.

An Easyhand Pro Rapid 120 with vacuum pump D is recommended (incl. test) for very porous cardboard boxes from approx. 10 kg to approx. 20 kg.

An Easyhand Pro Rapid 120 with vacuum pump D is recommended (incl. test) for cardboard boxes from approx. 20 kg to a max. of 35 kg with a faster lifting speed.



Overhead crane system

Freedom of movement in large work areas

Movomech's lightweight overhead crane system, **Mechrail™**, consists of extruded aluminium profiles to which trolleys, suspension systems and accessories are fitted to provide ergonomic and flexible movement in x/y joints during lifting operations.

The aluminium profiles in the Mechrail™ system have been designed for maximum strength and torsion rigidity in combination with a very low weight, which makes Mechrail™ a very light and ergonomic overhead crane system.

The Mechrail™ crane system is easy to install and can be extended or supplemented as needed.



Mechrail™ overhead crane system

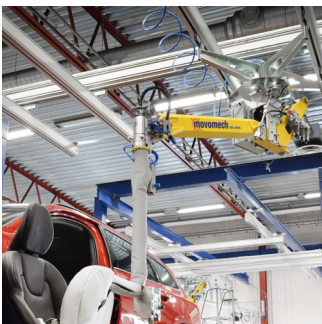

- ✓ Very low rolling resistance for ergonomic handling
- ✓ Meets the automotive industry's high ergonomic and accessibility requirements



- ✓ Large range of smart accessories
- ✓ Easy to install
- ✓ Modular design for easy extension



- ✓ Swedish design
- ✓ Developed in cooperation with fitters and operators

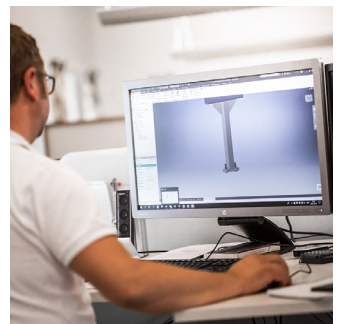

- ✓ Specially adapted as required
- ✓ Easily dimensioned with the ECONFIG™ configurator

The Mechrail™ aluminium crane system is designed to meet the market's strictest requirements for accessibility, safety and handling ergonomics.

Installation of vacuum lifters in overhead crane systems

Work area

A large work area with several workstations are easily and effortlessly reached with an overhead crane system.

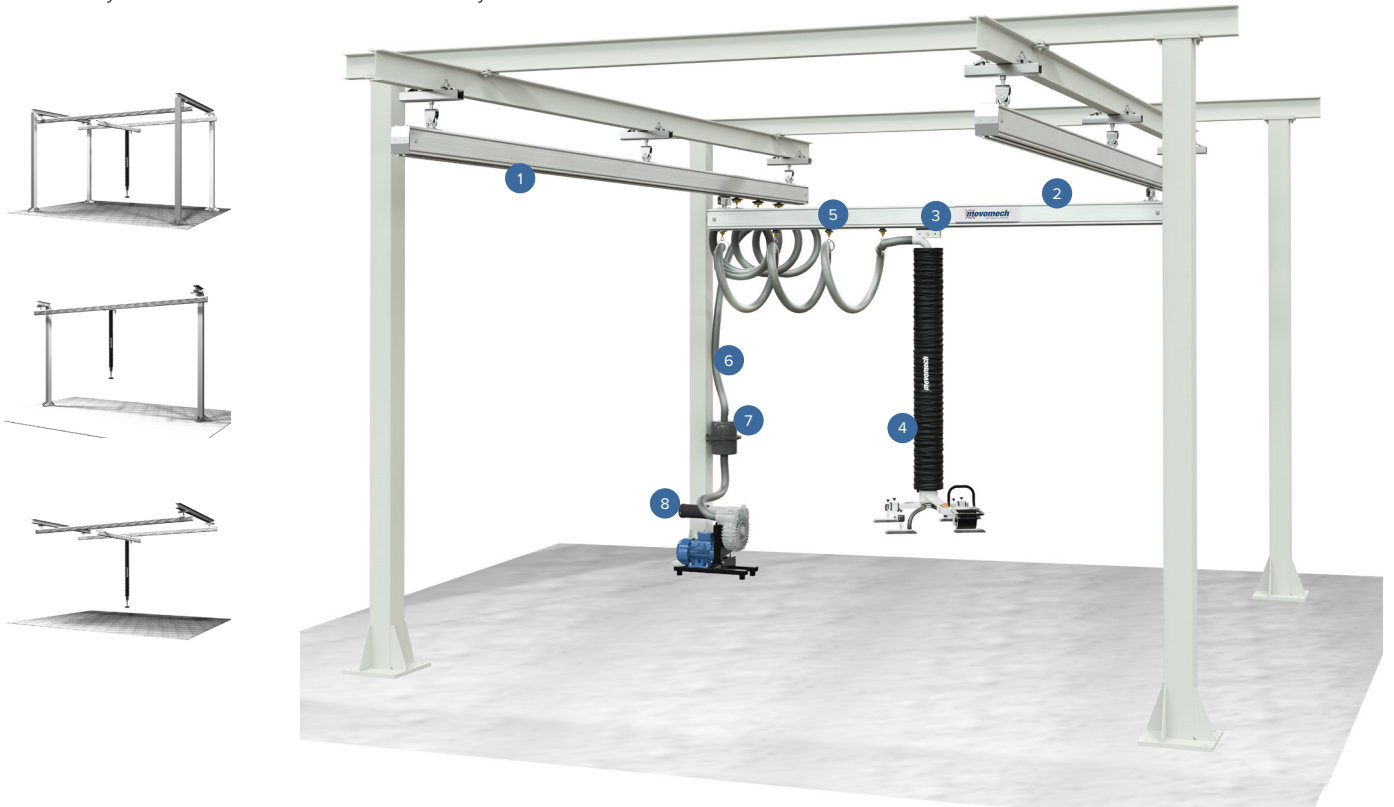

1. Track profile
2. Transversal profile
3. Trolley
4. Lifting unit
5. Trolley for media feed
6. Vacuum tube
7. Filter unit
8. Pump unit

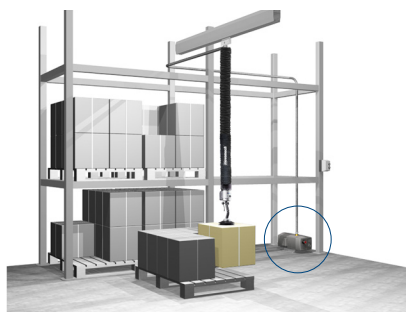

Vacuum pump

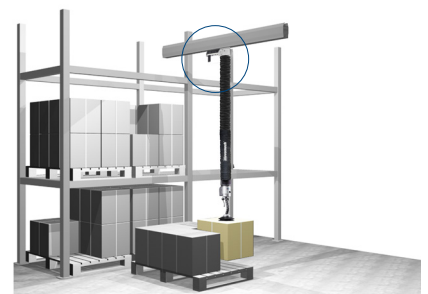

Ejector



Jib cranes

Fixed or mobile workstation

Movomech's range of ergonomic jib cranes includes a complete product series from wall-mounted jib cranes and pillar-mounted jib cranes in aluminium to complete lifting units with integrated lifting equipment.

A jib crane is a practical solution for the installation of vacuum lifters at a workstation.

Several of the jib cranes can be provided with a mobile platform for easy moving between different workstations.



Easycrane™ – mobile articulated jib crane with integrated vacuum lifter, see p. 26.



- ✓ Wall or pillar-mounted
- ✓ Stable powder-coated steel pillar
- ✓ Standard natural white or optional RAL colour



- ✓ Crane arm in strong and light aluminium profile
- ✓ Extremely mobile crane arms for good ergonomics



- ✓ Light rolling resistance trolley in aluminium
- ✓ Premium quality wheel bearings



- ✓ Customized jib cranes



Crane arms in strong and light aluminium offers an easy and flexible material handling.

Installation of vacuum lifters with jib cranes

Work area

A jib crane is an easy-to-install and practical solution for enabling access for the lifting aids to the entire work area.



Pillar-mounted jib crane



Wall-mounted jib crane

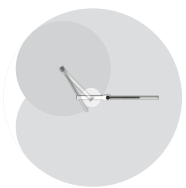

Articulated jib crane



Mechcrane™ LPS

1. Jib crane
2. Trolley
3. Lifting unit
4. Trolley for media feed
5. Vacuum tube
6. Filter unit
7. Pump unit
8. Pneumatic ejector

EASYCRANE™

The Easycrane™ series consists of flexible swing arm cranes with a vacuum lifter integrated in the swing arm – a complete workstation for quick and easy lifting!

With ample reach and an adjustable floor pillar, Easycrane™ is adaptable to most workplaces. Add a mobile platform and you can move Easycrane™ with a simple manual hand pallet truck between different workstations.

Easycrane™ is available in several models:

Easycrane Pro™ Easy one-handed lifting up to 50 kg

Easycrane M™ Panels and box lifting up to 50 kg

Easycrane V™ Bag lifting up to 50 kg

Easycrane Pro Rapid™ Quick parcel lifting up to 35 kg



MODEL EASYCRANE™		PRO + M	V	PRO RAPID
Max. capacity ¹	[kg]	5-50	5-50	5-35
Pump		C / D / K / I	F / G / H	C / D / K / I
Lifting tube ø	[mm]	60 / 80 / 100 / 120	140 / 160	80 / 100 / 120
Pillar height H	[mm]	1830-3290 ²		
Work area A+B	[mm]	2000 / 2500 / 3000 / 3500 / 4000		

¹ Depends on lifting tube, suction pad and handled object's porosity.

² Adjustable in increments of 100 mm.

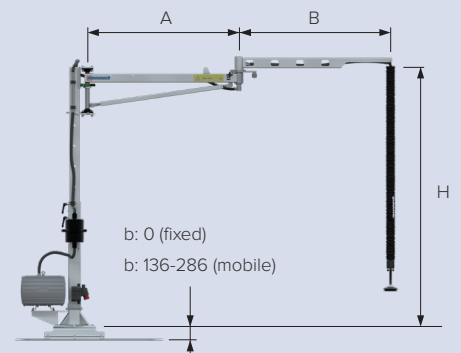

Mobiarm™ + ejector-driven vacuum lifter

If you choose an ejector-driven vacuum lifter, it can be easily combined with the mobile Mobiarm™ jib crane.

Sometimes, flexibility is most important. With a mobile platform, the vacuum lifter can be easily moved between different workstations.

- ✓ Complete ergonomic workstation
- ✓ Easy to use
- ✓ Increases productivity
- ✓ Fixed installation or with a mobile platform
- ✓ Comfortable handling even close to the pillar

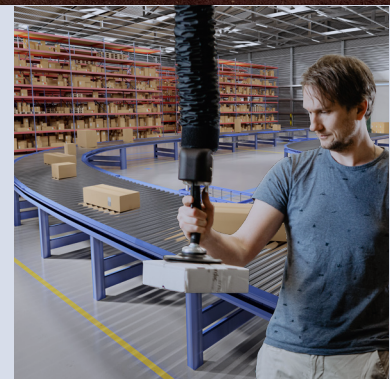

A version for every lifting need.



Easycrane Pro™

Provides comfortable and effortless one-handed handling of loads up to 50 kg.

Lifts cardboard boxes, crates, packets, bags and much more easily and simply.



Easycrane M™

A flexible vacuum lifter for many different lifted objects up to 50 kg.

With a fixed or articulated handle – practical for stacking products, sheet materials and crates.



Easycrane V™

A powerful vacuum lifter for bags or porous cardboard boxes up to 50 kg.

With a short handle for effortless bag handling or an extended handle for increased reach when stacking or handling bulky materials.



Easycrane Pro Rapid™

With a quick release function for quick and easy handling of loads up to 35 kg.

Designed for quick lifting at workstations in distribution and logistics.

WORLD-CLASS LIFTING SOLUTIONS

Products and systems from Movomech are used in many industries in many countries. Here is a selection of customers who have chosen the Movomech companies as their partner for streamlining production processes.



AUTOMOBILE

Audi | Autoliv | BMW | DAF | DaimlerChrysler | Faurecia | Ford | General Motors | Jaguar | Johnson Controls | Lear Corporation | MAN | Mercedes Benz | Nissan | Renault | Opel | Peugeot | Porsche Scania | Tower Automotive | Volkswagen | Volvo AB | Volvo Cars

LINE BUILDERS

ABB | Comau | Dürr | KUKA | Lear Corporation | Magna | ThyssenKrupp | TMS | VDL Steelweld

OTHER INDUSTRIES

ABB | Airbus | Alfa Laval | Arla | Arvin Meritor | Atlas Copco Secoroc | Atlas Copco Tools | Astra Zeneca | Ballingslöv | BT Industries | Cardo | Carglass | Carlsberg Sverige | Daloc | Danfoss | Doria DynaMate | Dynapac | Electrolux | European Furniture Group | Finja | GGP Sweden | Gustavsberg Husqvarna | IFÖ | Kilsgaard | Kinnarps | Orresta | Outokumpu | Pilkington | Randek BauTech | Saab AB | Schenk | SKF | Statoil | Swedoor | Tarkett | Westinghouse



Movomech AB +46 (0)44 28 29 00

www.movomech.com