

# Automotive Glass Replacement

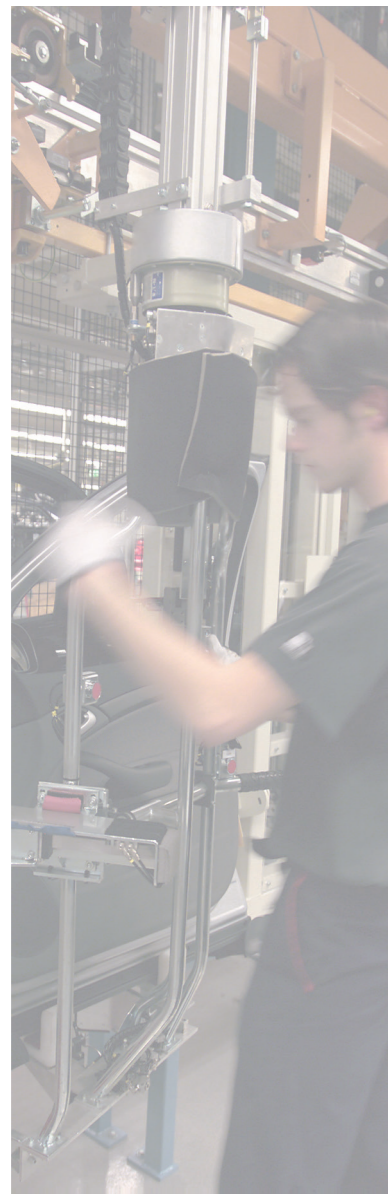
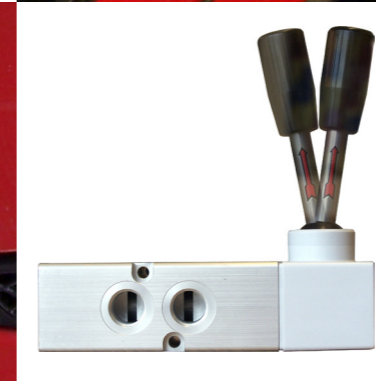

## Movomech AB

Box 9083  
SE-291 09 Kristianstad  
SWEDEN

Phone +46 44 282 900  
Fax +46 44 282 928  
E-mail [info@movomech.com](mailto:info@movomech.com)  
Web [www.movomech.com](http://www.movomech.com)

## Representatives

Sweden  
Belgium  
Denmark  
Finland  
France  
Germany  
Ireland  
The Netherlands  
Singapore  
Spain  
UK  
USA



Production-Layout Movomech AB 735818\_20150819

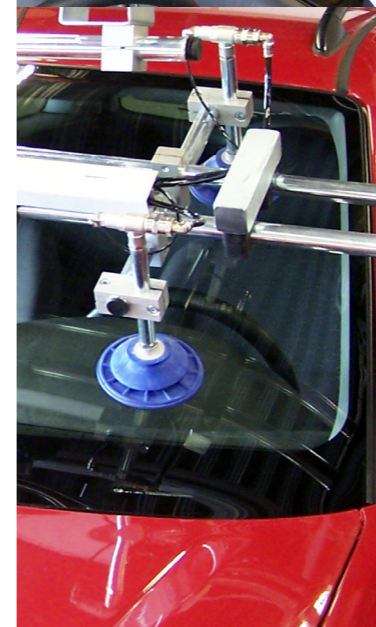

Make auto glass replacement into a one-man job that is...

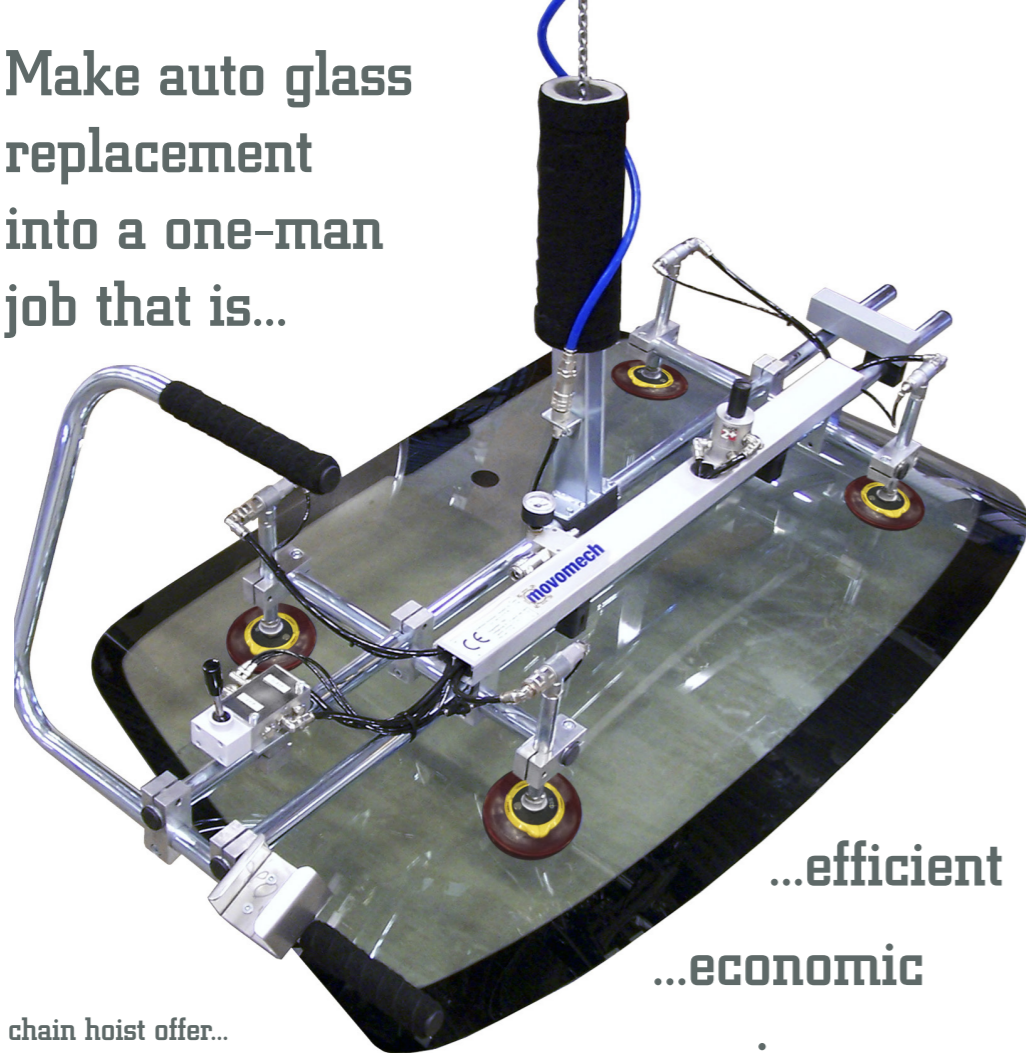

The chain hoist offer...

- ...efficient
- ...economic
- ...ergonomic

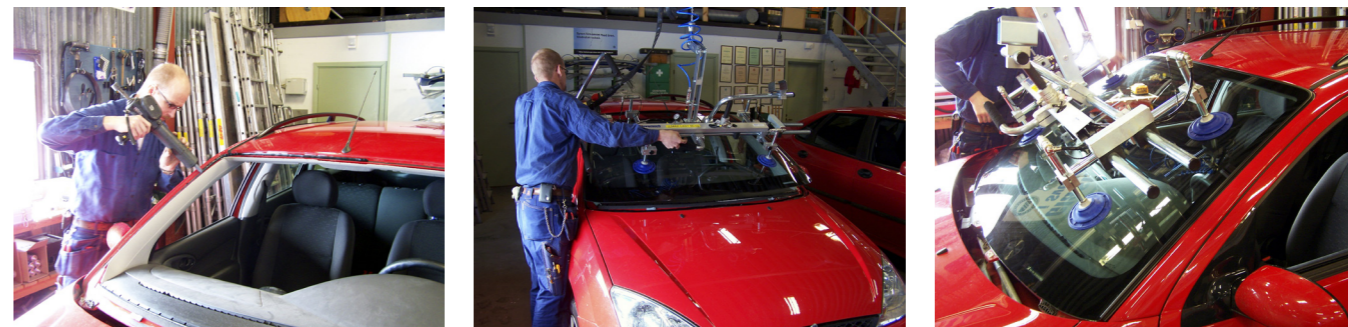

...variable speed transmission with creep speed function for high accuracy.

Several assembly possibilities makes the installation in Your facility simple...

**Mechrail**

- Ceiling mounted rail system
- For small or large working areas
- Flexible track/crane
- Easy to expand

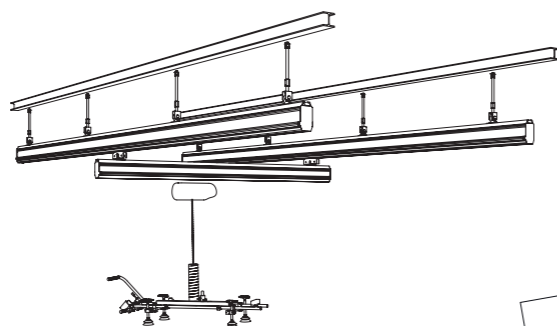

**Mechcrane**

- Wall mounted crane
- Free up floor space

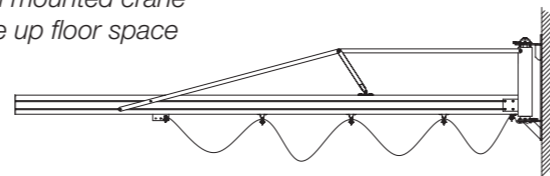

- Floor mounted crane
- Suitable almost everywhere

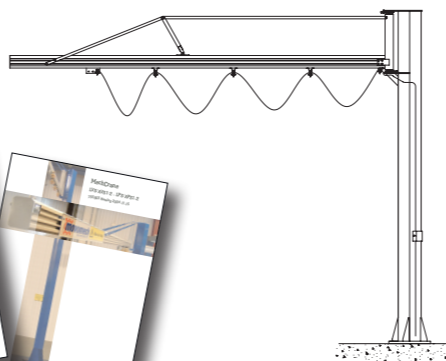

Mechrail & Mechcrane



Optional handling...



Windshield (bus)...



flat glass...



sheet metal...



or engine hood.

**Technical data**

**Chain hoist**

- Max capacity: 100 kg / 200 kg
- Stroke: 3000 mm
- Hoisting speed: 0.7-12 m/min
- Voltage supply: 230 V

**End effector**

- Max capacity: 80 kg / 110 kg
- Air supply: 6-7 bar (dry, non-lubricated, filtered)
- Noise level: < 70 dB (A)
- Air flow: 168 l<sub>n</sub>/min
- Tilt: 120°

**CE** Labelling according to Machine directive 2006/42/EG