



MECHRAIL[™]

ALUMINIUM CRANE SYSTEM

TABLE OF CONTENTS

ABOUT LIGHTWEIGHT OVERHEAD CRANE SYSTEMS.	4	MEDIA SUPPLY.	59
Terminology for overhead aluminium crane systems.	4	Spiral hose	59
General characteristics	5	Cable trolley for track profile	61
Material properties	5	Cable trolley for C-rail	68
Temperature and environmental conditions	5	Cable chain	76
Configuration example.	6	Power rail	79
SYSTEM DESIGN	17	Air preparation units	82
Tolerance requirements and installation dimensions.	18	Limit switches	83
Total installation height	22	Connection units.	84
Load charts.	24		
Classification of operations.	26		
Safety wire	27		
COMPONENTS.	28		
Crane system profiles	28		
Suspensions	32		
Safety wire for suspensions	37		
Trolleys	38		
End stops	40		
End covers	42		
Joint sets	43		
Crane girder suspensions.	44		
Triangular bracing	46		
Space saving modules.	47		
Safety wire for bridges.	49		
Distances for double cranes.	51		
Service hatches.	51		
Travel limiter.	52		
Friction rollers	54		
Spacer brace	55		
Parking brakes.	56		
Signs	57		
Fasteners and tools	58		

Although the greatest care was taken regarding the information in this catalogue, we assume no responsibility for any errors. We reserve the right to make changes.

The illustrations in the catalogue represent the described products, but delivered parts may differ in some respects from the illustrations.

The right is reserved to make changes in design and dimensions compared with the information in the catalogue in order enable development of designs, material and manufacturing methods.

The customer is reminded that in the purchase of our products for professional use or other, there is supplementary, current information that could not be included in the catalogue in terms of recommendations on each product's suitability regarding different combinations of the comprehensive product line of Movomech.

All relevant information must be provided to the persons who are responsible for the use of the product.

ABOUT LIGHTWEIGHT OVERHEAD CRANE SYSTEMS

This product catalogue describes the various components in the Mechrail range of equipment and basic rules for selection. The product catalogue supports other sales tools for a correct selection of products. This document contains standard products available in price lists and sales configurator as well as some special applications that require handling by the Movomech sales support department.

TERMINOLOGY FOR OVERHEAD ALUMINIUM CRANE SYSTEMS

Aluminium crane systems

A system with aluminium profiles in which trolleys, suspensions, lifting equipment and accessories are attached in order to provide ergonomic and flexible movement in the X and Y axes when lifting.

Runway track

Stationary aluminium profiles on which a hoist or other lifting equipment travels. A runway usually consists of two runway profiles, but may also be a single track runway or a triple track runway solution.

Suspension

Clamps, threaded bars and other components that attach the runway of the system to a ceiling-mounted beam structure or a floor-mounted supporting structure.

Span

The horizontal distance between the centre-lines of the runway profiles.

Crane bridge

Aluminium profile holding the lifting device, mounted in trolleys which travel along the track runway.

Rated capacity

The maximum load that the crane system is designed to carry in a certain configuration and operating in normal use. The load includes the weight of the lifting equipment and the gripping tool, dynamic forces arising from the operations, and the weight of the lifted item.

Also refer to the section Design.

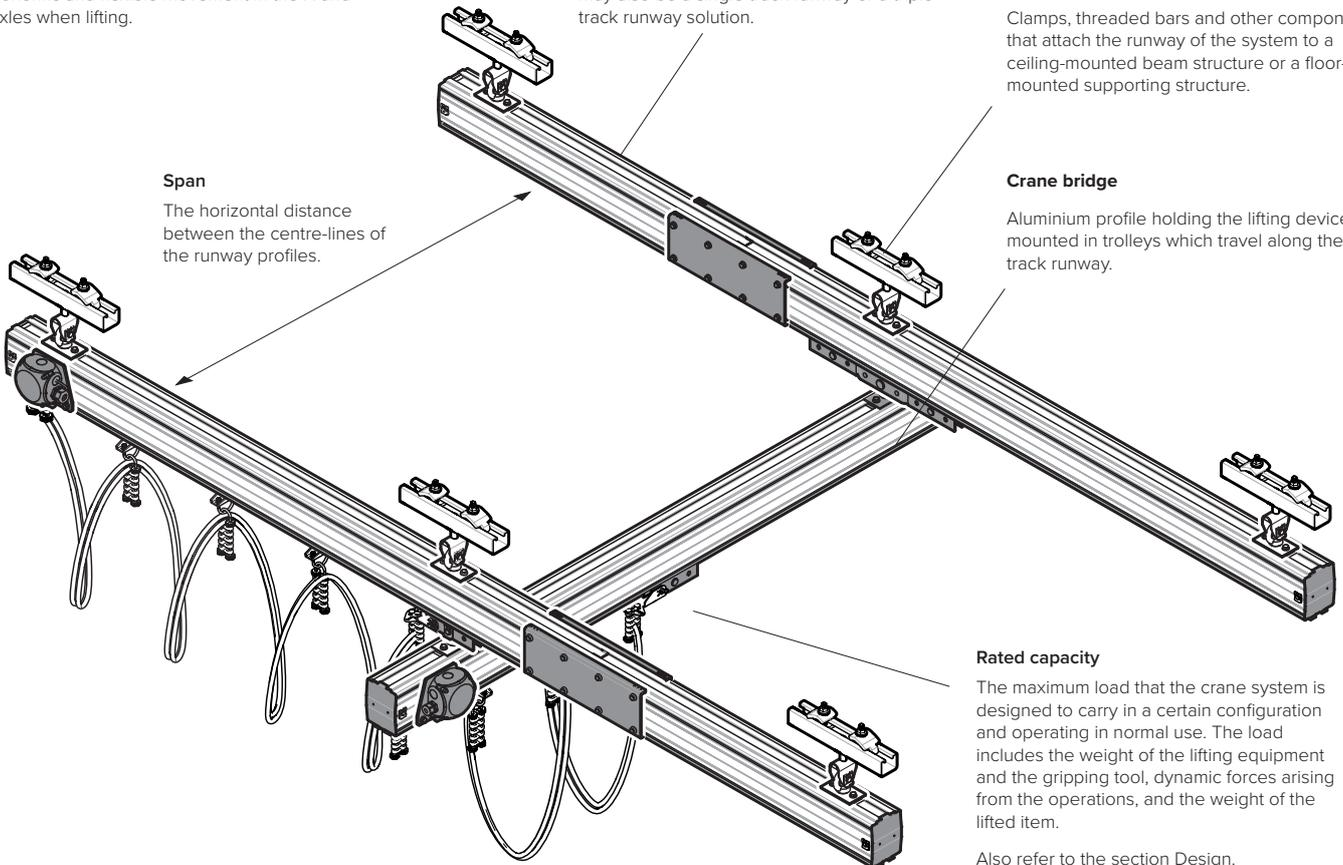

An example of a simple ceiling-mounted overhead crane system for e.g. lifting with an electric chain hoist.

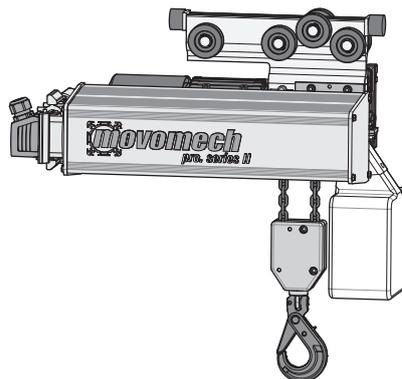

Lifting equipment

The equipment for lifting and lowering a load.

GENERAL CHARACTERISTICS

Mechrail™ aluminium crane system

Mechrail™ is a modular lightweight overhead crane system of light aluminium profiles for manual or powered handling of goods, designed to be used together with a number of different lifting devices.

The lightweight overhead crane system is designed to be attached to a ceiling-mounted beam structure or a floor-mounted supporting structure. The system must be dimensioned for the forces acting on it when in operation, and this must be verified before commissioning the overhead crane system.

Because of the hanging design, most configurations will only have downward-going forces on the supporting structure. An exception when upward-going forces are created, is if e.g. a torque absorbing load manipulator is mounted close to a runway.

Technical regulations

The Movomech range of products are designed according to the state of the art for technical equipment, and meets the requirements in the applicable European Norms and Regulations. The Standards and Directives that apply to the product are stated in the Declaration of Conformity or the Manufacturers declaration supplied with the product.

Safety precautions

The documentation provides appropriate instructions for the user to ensure safe operation and simple maintenance.

All personnel that transport, install, put into use, operate, maintain and repair the Movomech equipment and attached equipment must have read and understood:

- the Operating Instructions,
- the Safety Instructions, and
- the Safety Precautions in the various sections.

To avoid erroneous use and to ensure uninterrupted operation with our products, these Operating Instructions must always be available for the user/operator.

Installing the crane system

The overhead crane system must be installed using authentic components supplied or approved by Movomech. Components from other sources may carry a risk for the equipment or the personnel and voids any warranty claim.

When installing the equipment all safety and installing instructions in the manual must be observed and the installation work must be documented. During the installation work the work area must be closed for unauthorized persons.

The installation work requires skilled personnel and suitable tools in order to ensure safe and reliable operation. We recommend that the installation work is only performed by authorized personnel or an experienced service technician, authorized by the manufacturer.

Preventive maintenance

The overhead crane system is designed using modular components requiring minimal maintenance. As a general rule, the tightening torques of the screw joints must be checked regularly, and also the state of the safety equipment and wear parts. The intervals for preventive maintenance depend on the actual usage of the system, but should be performed at least annually.

See the product manual for further information.

MATERIAL PROPERTIES

Crane system profiles

The Mechrail crane system profiles are made of anodized aluminium and require no maintenance. They are manufactured in EN-AW 6063 T6 aluminium alloy according to SS-EN 755-2:2016, anodized colour C0 (natural).

Accessory range

A large part of the components in the Mechrail range are coated by galvanizing or anodizing, which makes them better resistant against wear and tear than painted components.

TEMPERATURE AND ENVIRONMENTAL CONDITIONS

Temperature and environmental limitations

This product is designed to be used indoors in typical industrial environments such as in the automotive industry production and general manufacturing.

Temperature range +5 to +40 °C.

Atmospheric corrosion category C2.

Noise level < 70dB (A).

ATEX

This product is not ATEX classified according to the EU directive for equipment in explosive environments.

CONFIGURATION EXAMPLE

Example 1: Single runway

Single runway - flexible suspension

Media supply - cable trolleys

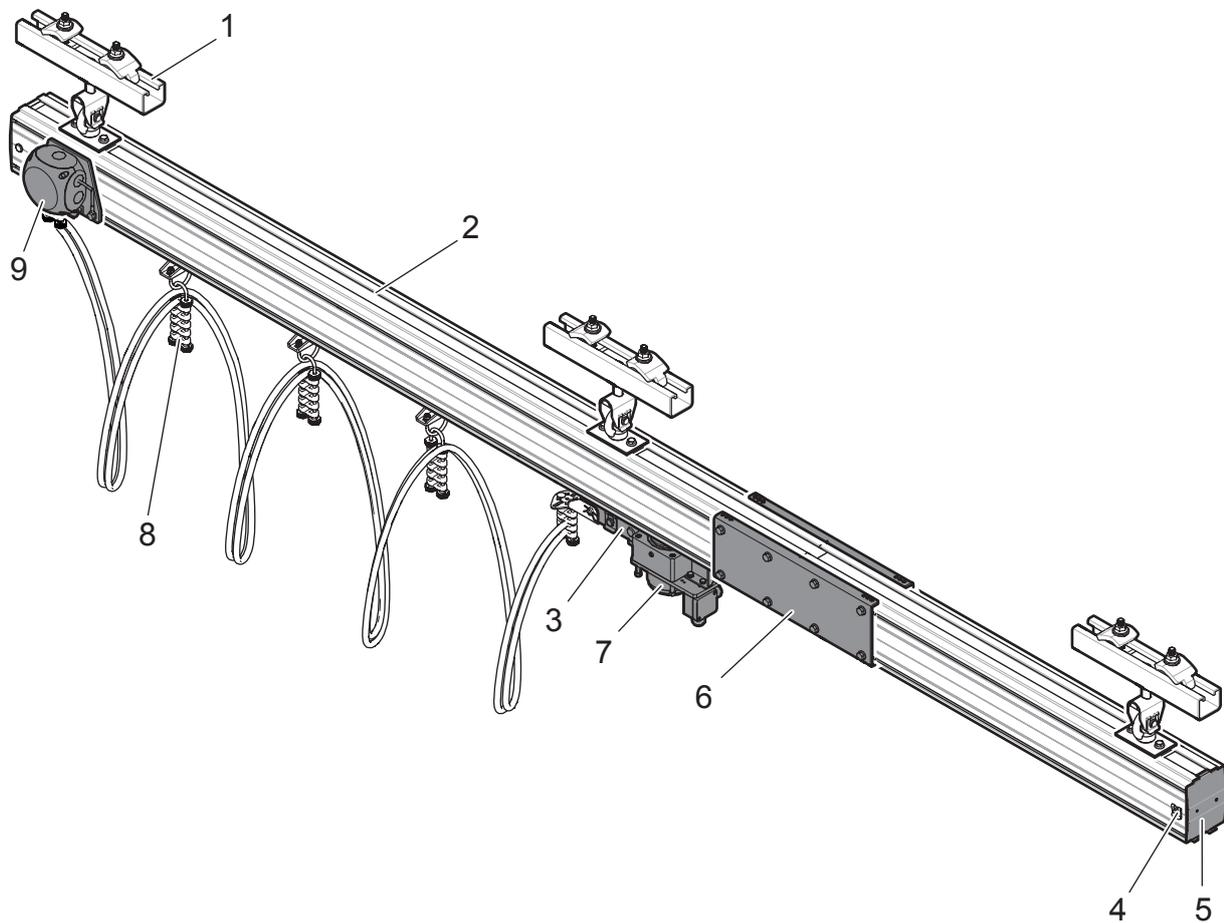

Pos.	Component	Type	Section catalogue page	Note
1	Suspension of runway	(A) Short	page 32	
2	Profile, runway	AHB140	page <?>	
3	Trolley	(A) Single trolley	page 38	
4	End stop	AHB140/190	page 40	
5	End cover	AHB140	page 42	
6	Joint set	AHB140	page 43	
7	Brake	(A) Electric 230 V	page 56	
8	Media supply	Cable trolley	page 61	
9	Connecting unit	AHB140/190	page 84	

A single runway is used in applications that only require movement in one direction.

Example 2: Single bridge

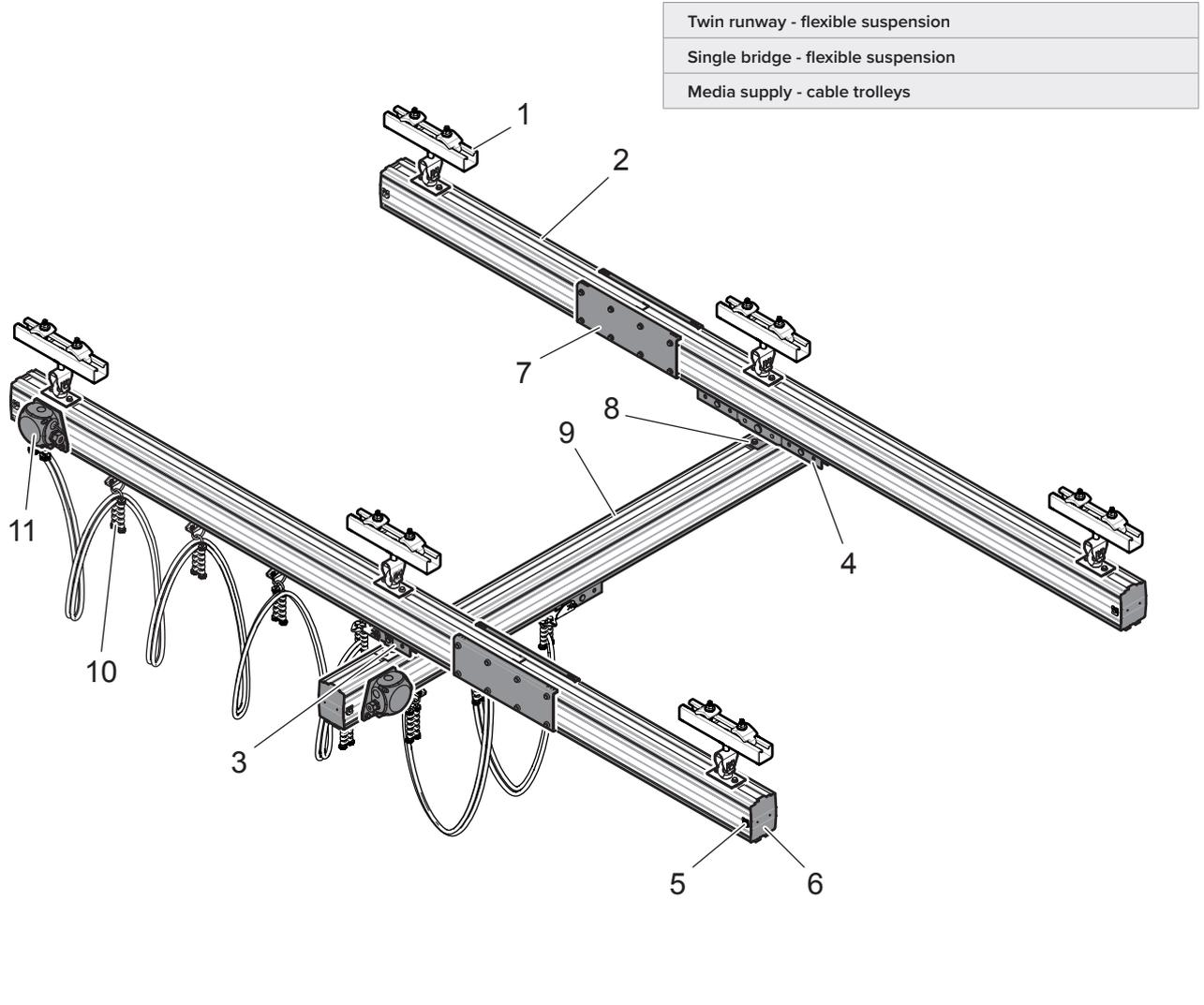

Pos.	Component	Type	Section catalogue page	Note
1	Suspension of runway	(A) Short	page 32	
2	Profile, runway	AHB140	page <?>	
3	Trolley	(A) Single trolley	page 38	
4	Trolley	(B) Double trolley	page 38	
5	End stop	AHB140/190	page 40	
6	End cover	AHB140	page 42	
7	Joint set	AHB140	page 43	
8	Bridge suspension	Crane girder suspension (A)	page 44	
9	Profile, bridge	AHB140	page <?>	
10	Media supply	Cable trolley	page 61	
11	Connecting unit	AHB140/190	page 84	

Twin runway with single bridge suspended in a crane girder suspension (A) is the most common way to configure a rail system when using non-torque absorbing lifters.

Example 3: Long suspensions and triangular bracing

Twin runway - flexible suspension, hanging low and braced

Single bridge - rigid suspension in triangular bracing

Media supply - spiral hose

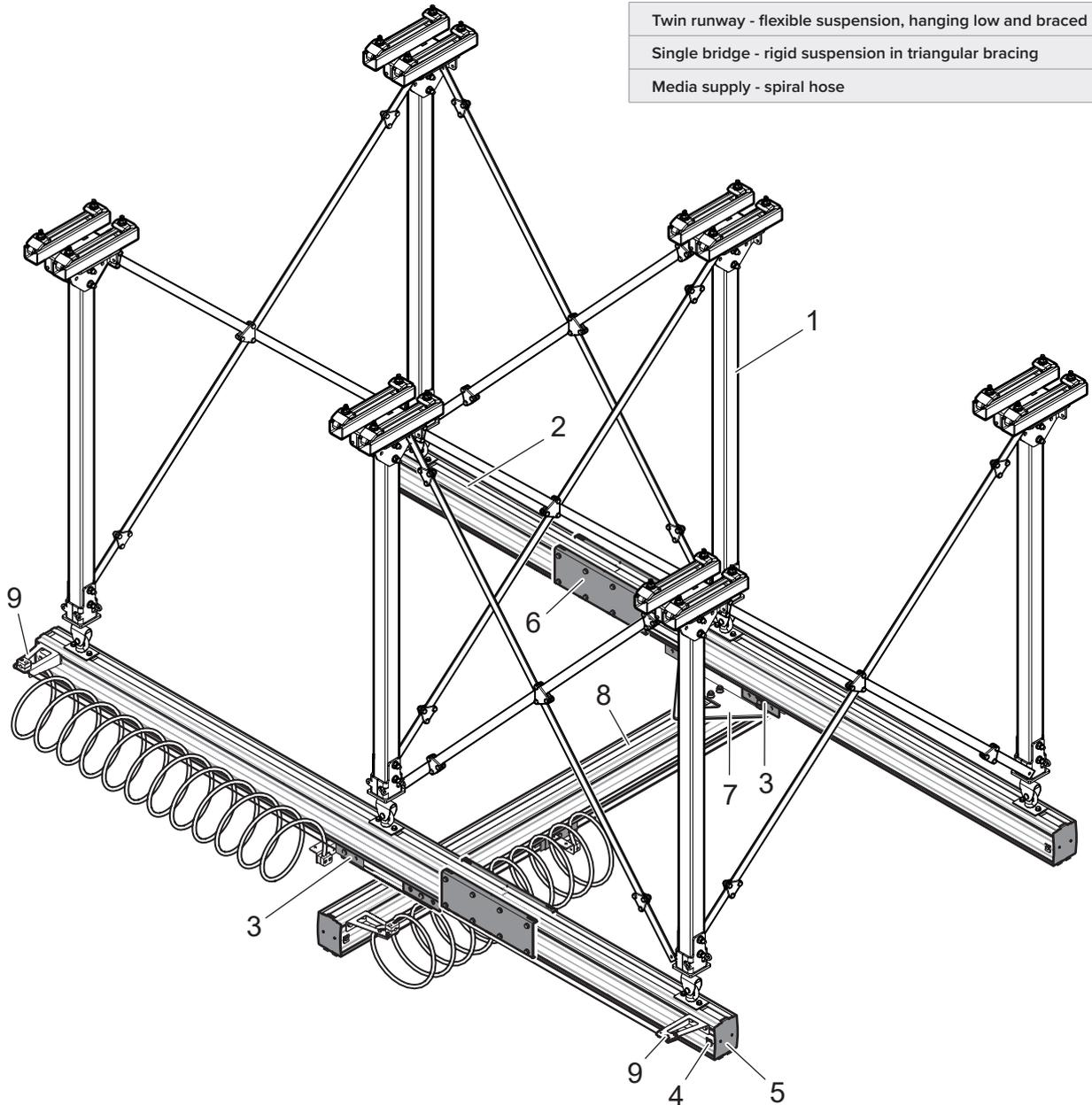

Pos.	Component	Type	Section catalogue page	Note
1	Suspension of runway	(C) Long	page 32	
2	Profile, runway	AHB140	page <?>	
3	Trolley	(A) Single trolley	page 38	
4	End stop	AHB140/190	page 40	
5	End cover	AHB140	page 42	
6	Joint set	AHB140	page 43	
7	Bridge suspension	Triangular bracing	page 46	
8	Profile, bridge	AHB140	page <?>	
9	Media supply	Spiral hose	page 59	

Suspension (C) Long is used when the overhead beams are higher up than necessary, and the crane system needs to be hanging low. Triangular bracing provides a rigid mounting that only allows movement in the direction of the runway profile.

Example 4: Single bridge with space saving module

Twin runway - flexible suspension, hanging low

Single bridge - rigid suspension with space saving module

Media supply - cable chain

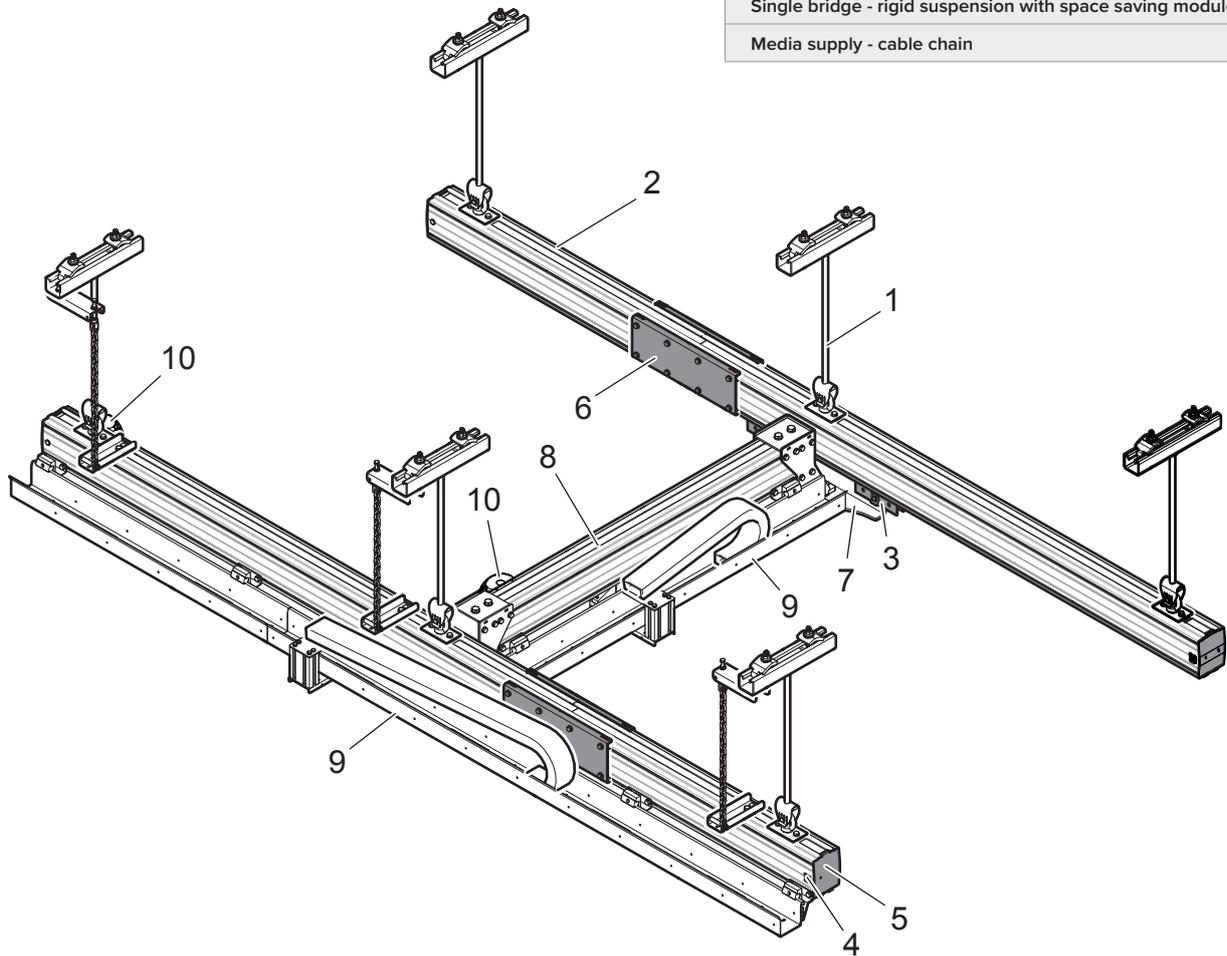

Pos.	Component	Type	Section catalogue page	Note
1	Suspension of runway	(B) Intermediate	page 32	
2	Profile, runway	AHB140	page <?>	
3	Trolley	(A) Single trolley	page 38	
4	End stop	AHB140/190	page 40	
5	End cover	AHB140	page 42	
6	Joint set	AHB140	page 43	
7	Bridge suspension	Space saving module	page 47	
8	Profile, bridge	AHB140	page <?>	
9	Media supply	Cable chain	page 76	
10	Connecting unit	AHB140/190	page 84	

A space saving module in the bridge minimizes the total height of the crane system and is used in buildings with low ceiling height.

Example 5: Twin bridge

Twin runway - flexible suspension

Twin bridge - flexible suspension

Media supply - cable trolleys

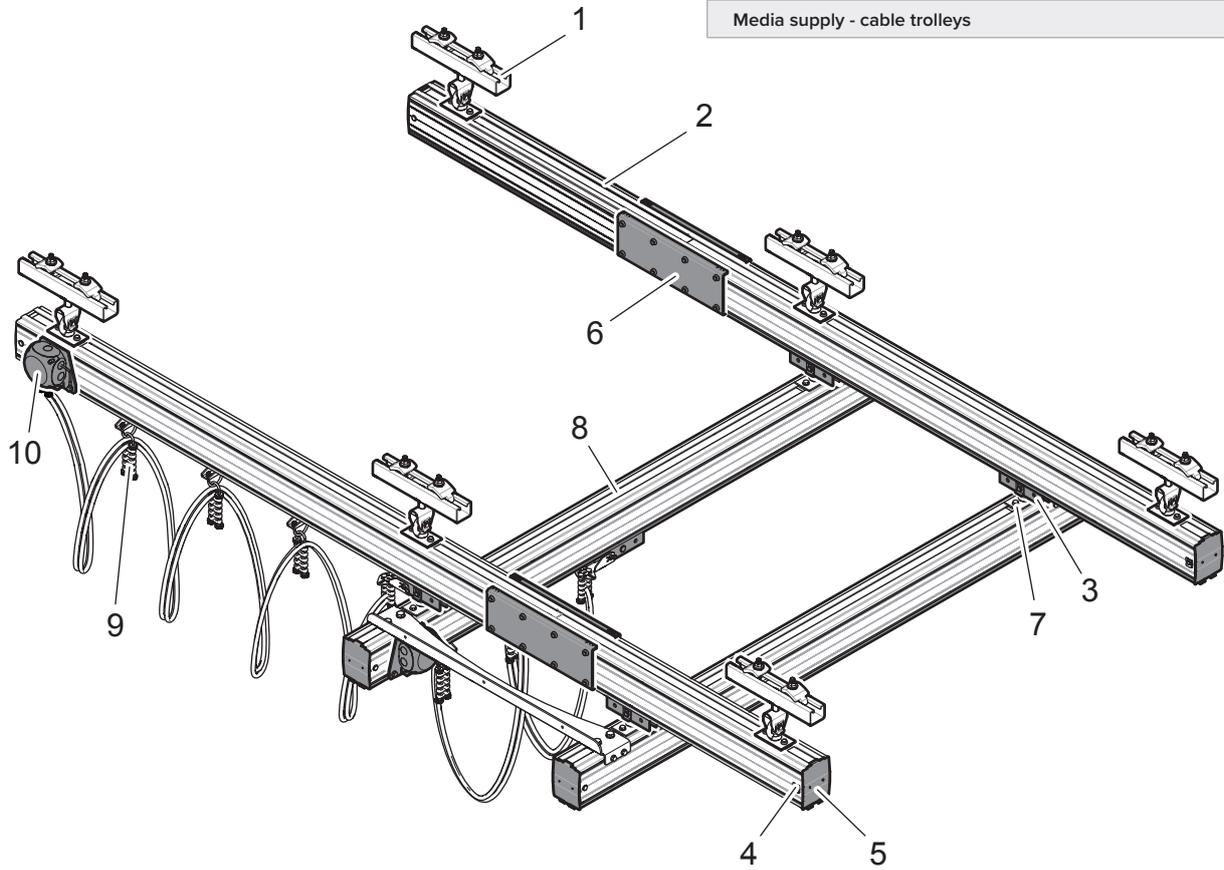

Pos.	Component	Type	Section catalogue page	Note
1	Suspension of runway	(A) Short	page 32	
2	Profile, runway	AHB140	page <?>	
3	Trolley	(A) Single trolley	page 38	
4	End stop	AHB140/190	page 40	
5	End cover	AHB140	page 42	
6	Joint set	AHB140	page 43	
7	Bridge suspension	Crane girder suspension (A)	page 44	
8	Profile, bridge	AHB140	page <?>	
9	Media supply	Cable trolley	page 61	
10	Connecting unit	AHB140/190	page 84	

Twin runway with twin bridge suspended in crane girder suspension (A) is the most common way to configure a crane system when using torque absorbing lifters.

Example 6: Twin bridge with space saving module

Twin runway - flexible suspension

Twin bridge - rigid suspension with space saving module

Media supply - cable trolleys in C-profile

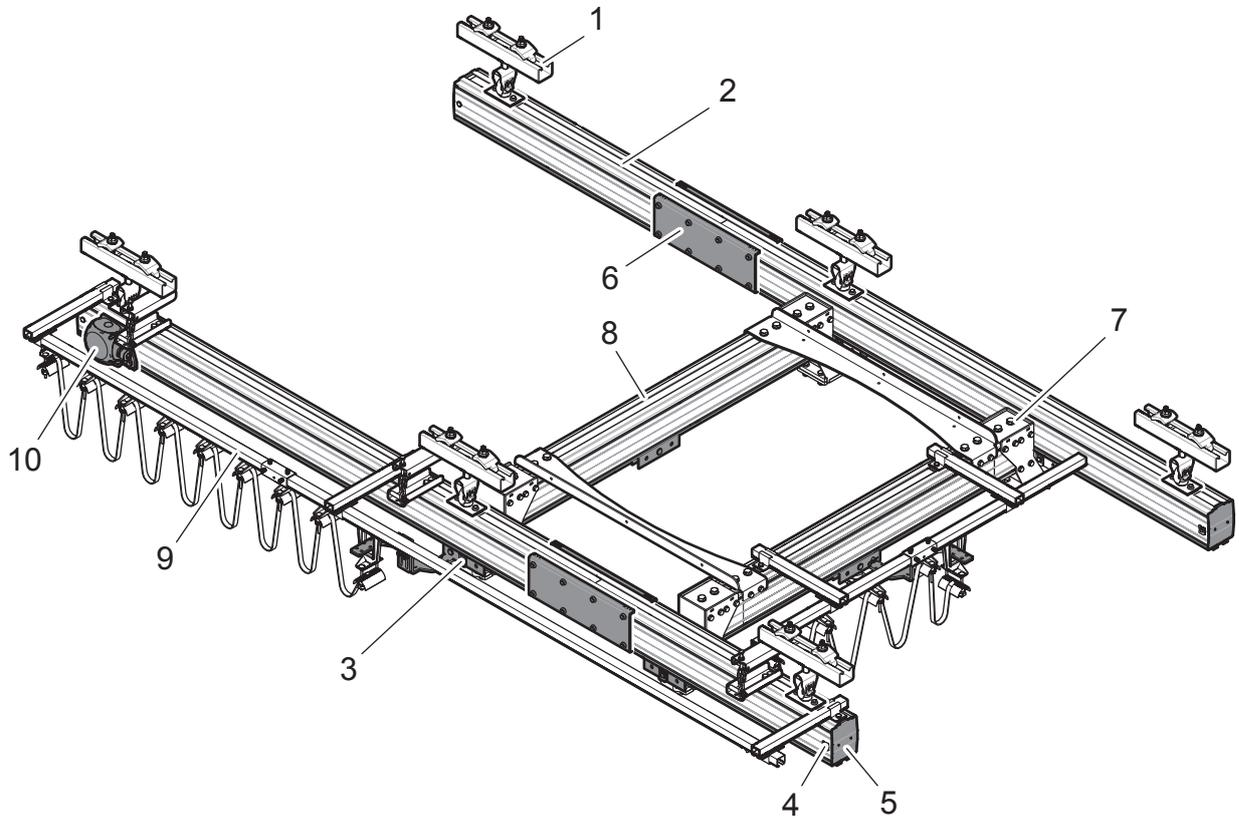

Pos.	Component	Type	Section catalogue page	Note
1	Suspension of runway	(A) Short	page 32	
2	Profile, runway	AHB140	page <?>	
3	Trolley	(A) Single trolley	page 38	
4	End stop	AHB140/190	page 40	
5	End cover	AHB140	page 42	
6	Joint set	AHB140	page 43	
7	Bridge suspension	Space saving module	page 47	
8	Profile, bridge	AHB140	page <?>	
9	Media supply	Cable trolley in C-profile	page 68	
10	Connecting unit	AHB140/190	page 84	

A cable trolley in C-profile is used to be able to range over a longer work area, and to avoid cables and hoses hanging down in the work area.

Example 7: Triple runway

Triple runway - flexible suspension

Single bridge - rigid suspension in triangular bracing

Media supply - spiral hose

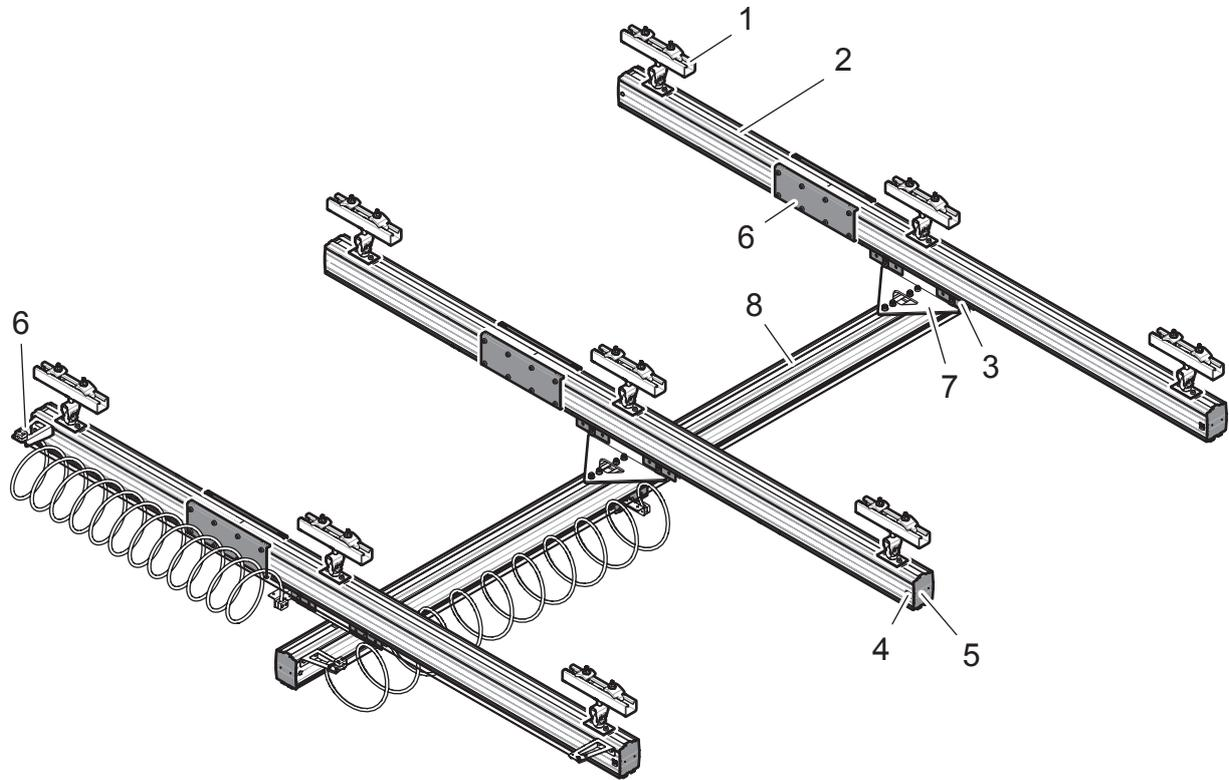

Pos.	Component	Type	Section catalogue page	Note
1	Suspension of runway	(A) Short	page 32	
2	Profile, runway	AHB140	page <?>	
3	Trolley	(A) Single trolley	page 38	
4	End stop	AHB140/190	page 40	
5	End cover	AHB140	page 42	
6	Joint set	AHB140	page 43	
7	Bridge suspension	Triangular bracing	page 46	
8	Profile, bridge	AHB140	page <?>	
9	Media supply	Spiral hose	page 59	

Triple runway system makes it possible for the bridge to have a larger span.

Example 8: Single bridge with overhang

Twin runway - rigid suspension, tight

Single bridge - flexible suspension

Media supply - power rail

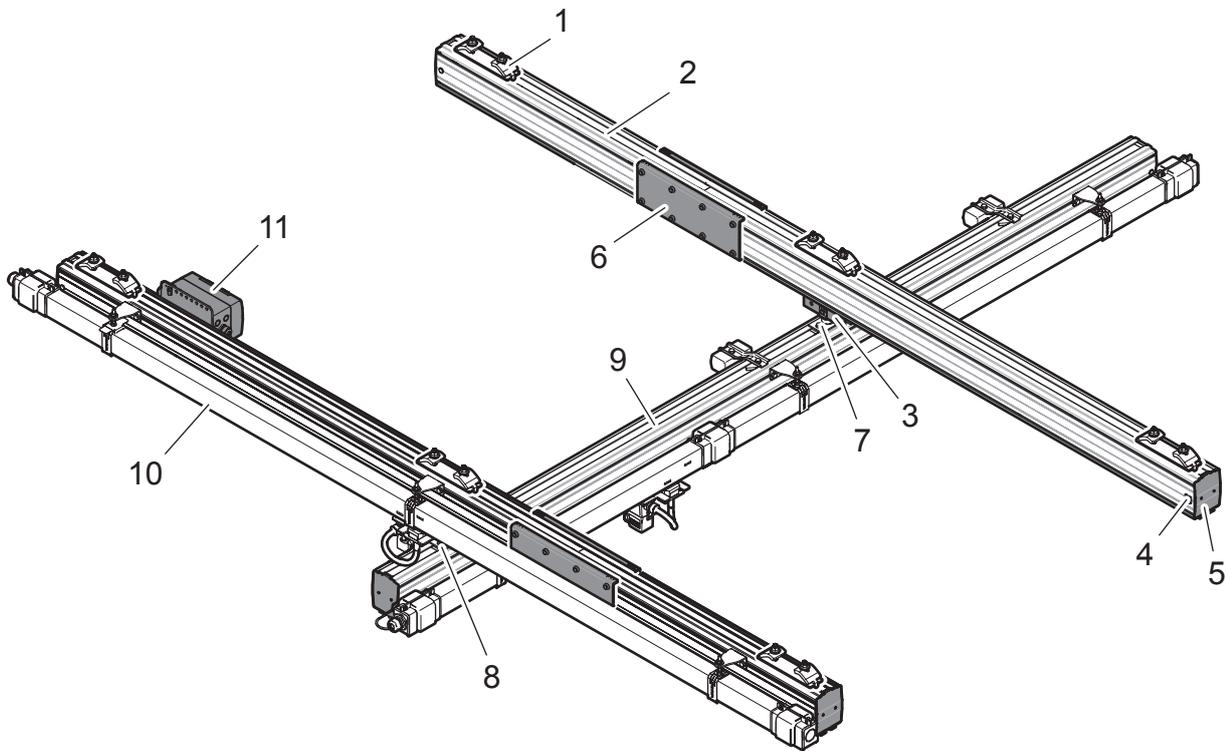

Pos.	Component	Type	Section catalogue page	Note
1	Suspension of runway	(D) Tight	page 32	
2	Profile, runway	AHB140	page <?>	
3	Trolley	(A) Single trolley	page 38	
4	End stop	AHB140/190	page 40	
5	End cover	AHB140	page 42	
6	Joint set	AHB140	page 43	
7	Bridge suspension	Crane girder suspension (A)	page 44	
8	Bridge suspension	Crane girder suspension (C) - ball joint	page 44	For forces directed upwards
9	Profile, bridge	AHB140	page <?>	
10	Media supply	Power rail	page 79	
11	Connecting unit	Fuse box AHB140/190	page 84	

The preferred solution when supplying power to several bridges.

Example 9: Tight single bridge with overhang and triangular bracing

- Twin runway - adjustable rigid suspension
- Single bridge - rigid suspension in triangular bracing
- Media supply - spiral hose

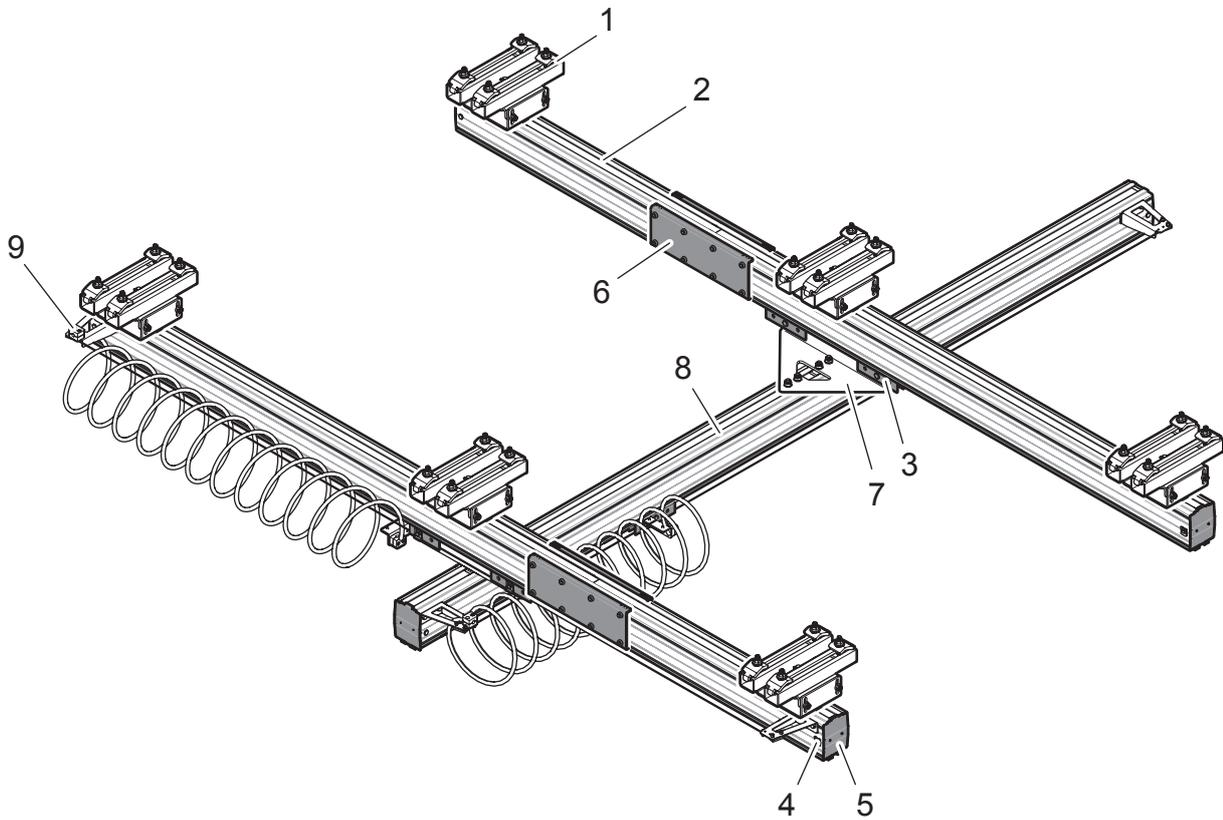

Pos.	Component	Type	Section catalogue page	Note
1	Suspension of runway	(F) Tight, adjustable	page 32	For forces directed upwards
2	Profile, runway	AHB140	page <?>	
3	Trolley	(A) Single trolley	page 38	
4	End stop	AHB140/190	page 40	
5	End cover	AHB140	page 42	
6	Joint set	AHB140	page 43	
7	Bridge suspension	Triangular bracing	page 47	For forces directed upwards
8	Profile, bridge	AHB140	page <?>	
9	Media supply	Spiral hose	page 59	

Tight, adjustable suspension (F) is used for systems that have a single bridge, subject to forces directed upwards, e.g. when the bridge has a major part hanging outside the runway, or in case of a telescoping crane.

Example 10: Tight twin bridge

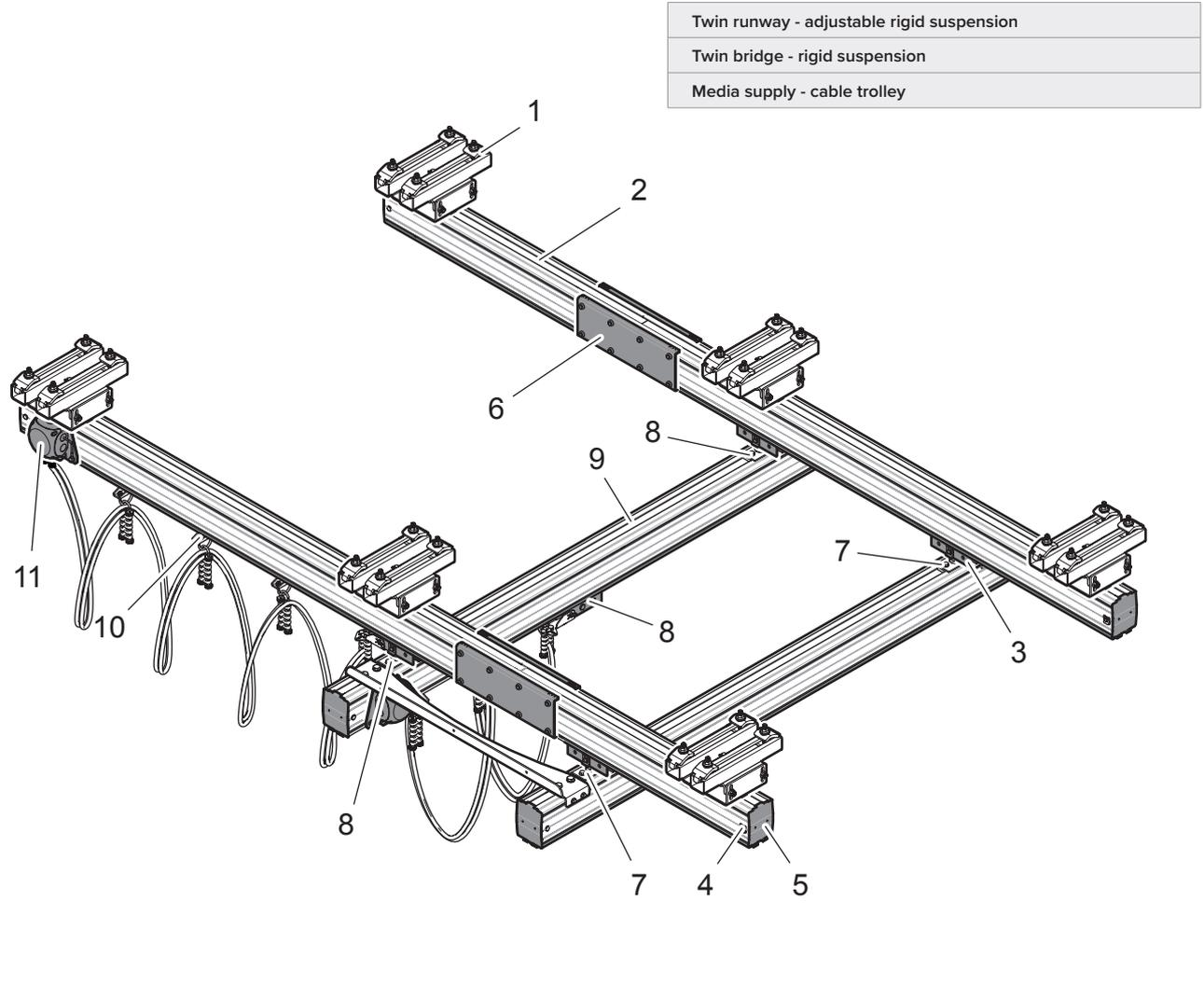

Twin runway - adjustable rigid suspension

Twin bridge - rigid suspension

Media supply - cable trolley

Pos.	Component	Type	Section catalogue page	Note
1	Suspension of runway	(F) Tight, adjustable	page 32	For forces directed upwards
2	Profile, runway	AHB140	page <?>	
3	Trolley	(A) Single trolley	page 38	
4	End stop	AHB140/190	page 40	
5	End cover	AHB140	page 42	
6	Joint set	AHB140	page 43	
7	Bridge suspension	Crane girder suspension (C)	page 44	For forces directed upwards
8	Bridge suspension	Crane girder suspension (A)	page 44	
9	Profile, bridge	AHB140	page <?>	
10	Media supply	Cable trolley	page 61	
11	Connecting unit	(C) Round / round	page 84	

Tight, adjustable suspension (F) is used for systems that have a twin bridge subject to forces directed upwards, e.g. when using torque absorbing lifters, or in case of a telescoping crane.

Example 11: Telescoping single bridge

Twin runway - adjustable rigid suspension
Single bridge - flexible suspension
Telescoping bridge - flexible suspension
Media supply - spiral hose

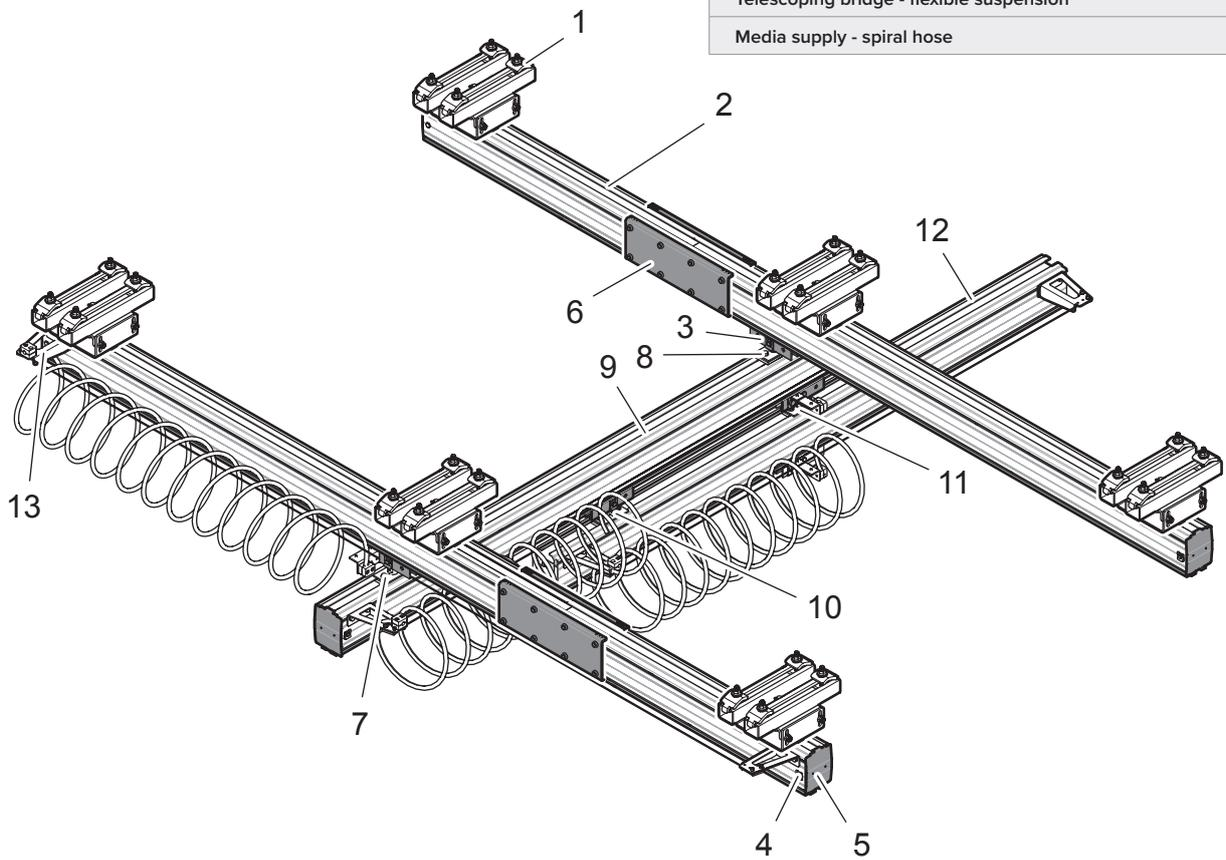

Pos.	Component	Type	Section catalogue page	Note
1	Suspension of runway	(F) Tight, adjustable	page 32	For forces directed upwards
2	Profile, runway	AHB140	page <?>	
3	Trolley	(A) Single trolley	page 38	
4	End stop	AHB140/190	page 40	
5	End cover	AHB140	page 42	
6	Joint set	AHB140	page 43	
7	Bridge suspension	Crane girder suspension (C) - ball joint	page 44	For forces directed upwards
8	Bridge suspension	Crane girder suspension (A)	page 44	
9	Profile, bridge	AHB140	page <?>	
10	Suspension of telescoping bridge	Crane girder suspension (C)	page 44	For forces directed upwards
11	Suspension of telescoping bridge	Crane girder suspension (A)	page 44	
12	Profile, telescoping bridge	AHB140	page <?>	
13	Media supply	Spiral hose	page 59	

A telescoping bridge is used e.g. when the crane rail needs to extend over an assembly line but to be out of the way as items move along the assembly line.

SYSTEM DESIGN

System design – EConfig

The Mechrail aluminium lightweight overhead crane system is a modern and modular system for loads up to 1000 kg.

It is vital that the system design is done correctly. Therefore it is necessary to read and understand the section System Design.

When deciding the size of the Mechrail lightweight overhead crane system, we recommend that you use the Movomech web based configuring tool - EConfig, at <http://www.movomech.com>.

Rated capacity

The rated capacity is the maximum load that the runway system is designed to carry in a certain configuration and in normal operation. The load includes the weight of the lifting equipment and the gripping tools, the weight of the lifted item, and dynamic forces arising from the operations.

When operating with torque absorbing lifting tools, telescoping bridges, etc., the toughest load case will be used for calculating the design.

Marking with the maximum permitted load

The crane system has a modular design and may be equipped with various types of lifting equipment. The main rule is that any part of the handling solution must be clearly marked with its respective maximum permitted load, see example below.

Ceiling-mounted steel structure

This design must be dimensioned for the forces acting on it when in operation, and this must be verified before commissioning the overhead crane system.

Because of the hanging design, most cases will only have downward-going forces on the supporting structure. An exception is in case upward-going forces are created, e.g. if a torque absorbing load manipulator is mounted close to a runway.

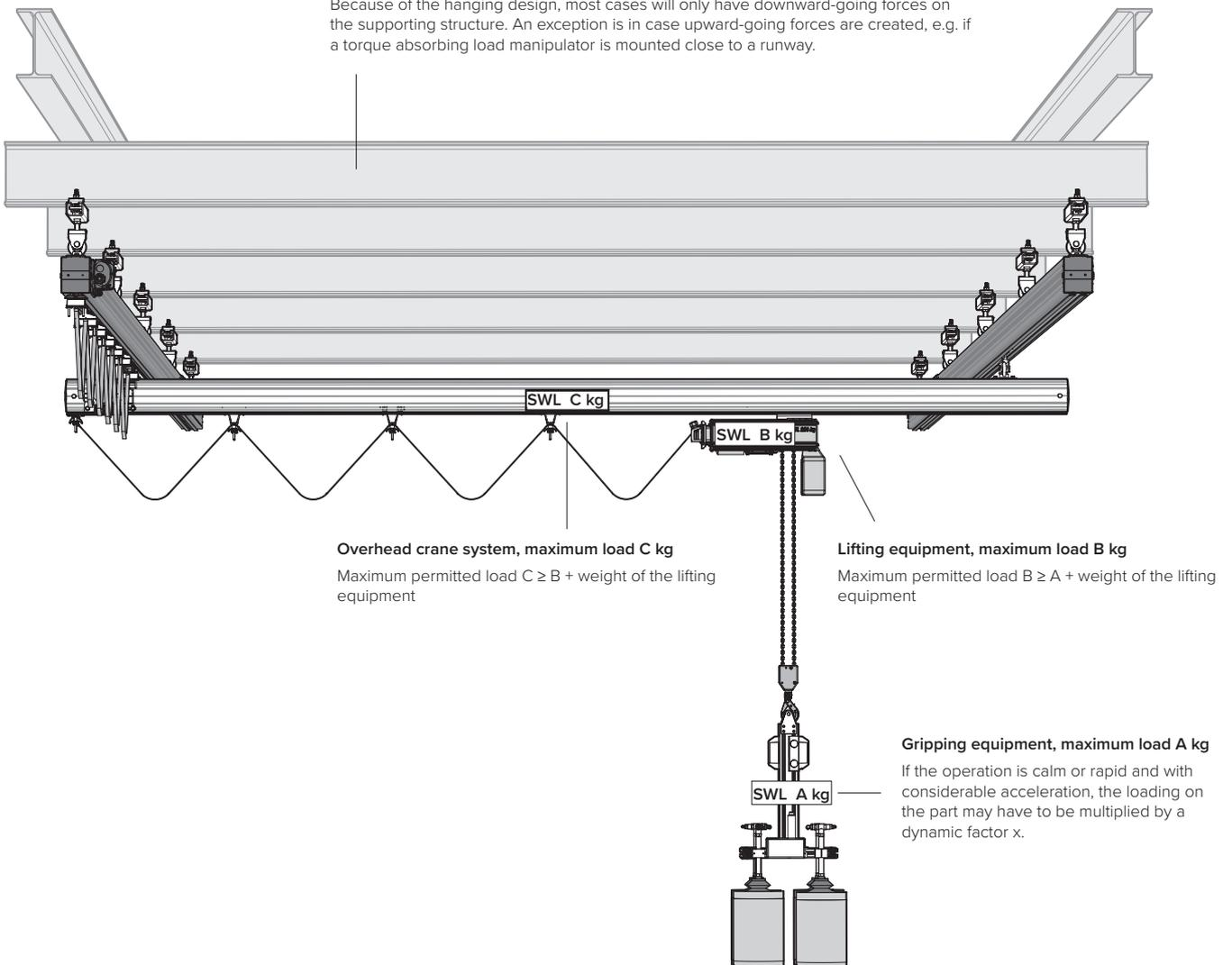

Example of marking for maximum permitted load for each level respectively in a simple ceiling-mounted overhead crane system.

TOLERANCE REQUIREMENTS AND INSTALLATION DIMENSIONS

Horizontal level - overhead beams

The overhead beams mustn't exceed the tolerance ± 10 mm in the horizontal level.

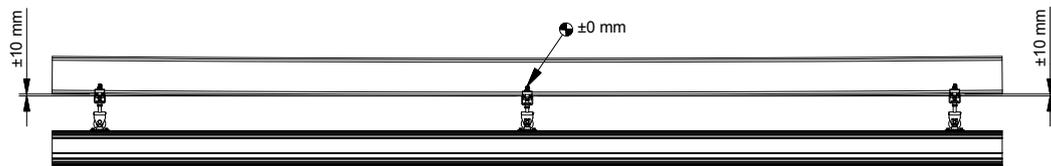

Installation dimensions

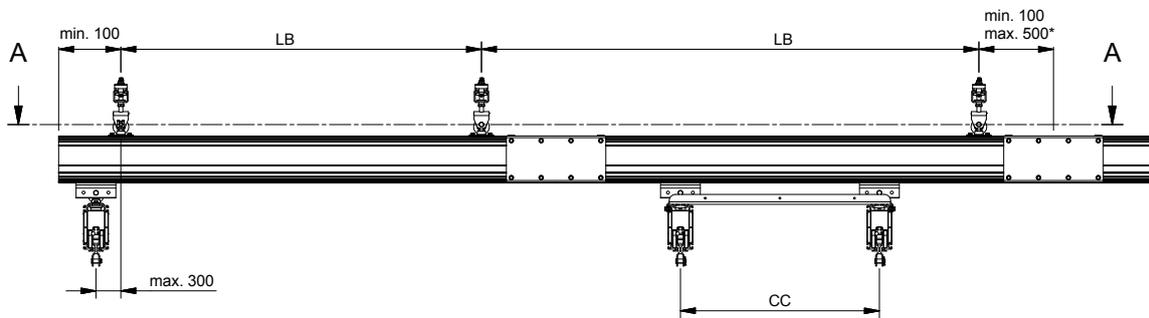

LB = runway hanging distance

LT = bridge length

LS = bridge span

CC = distance centre to centre, twin bridge

X = component-dependant distance

INFORMATION

Only one joint set may be fitted within the hanging distance LB and the distance from the suspension to the joint set may not exceed 500 mm. A joint set may only be used for bridges in three-string overhead crane systems. The above does not apply for AHB140/190 where the joint may be placed anywhere, but **the minimum distance from suspension to joint must always be 100 mm.**

Parallelism - twin runway

The suspensions for a twin runway cannot exceed the tolerance $\pm 0.5\text{‰}$ for parallelism.

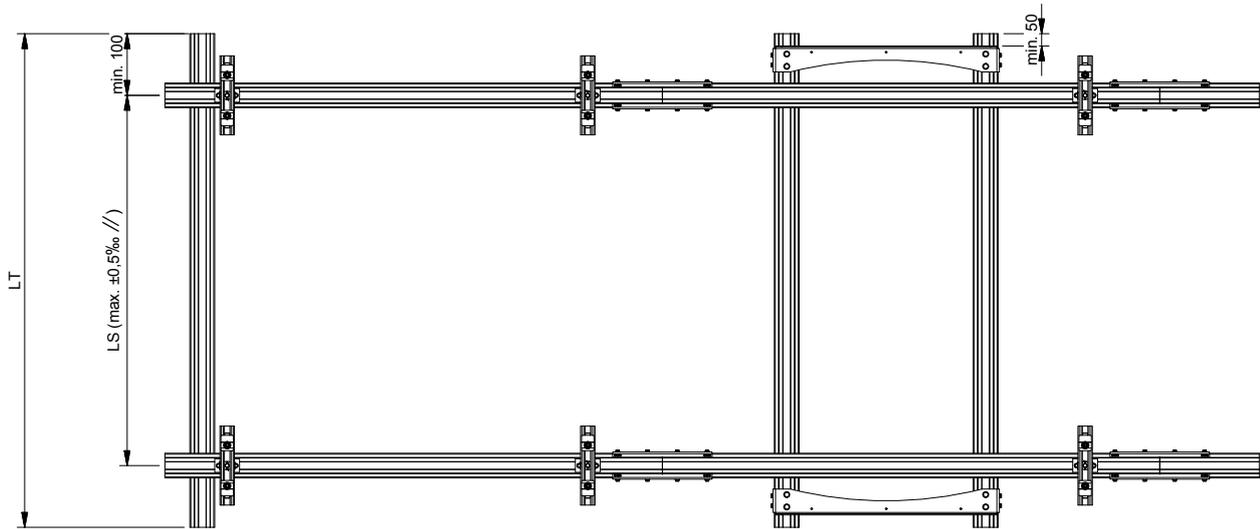

Straightness - runways

Suspensions for a runway must be placed with less deviation than $\pm 2\text{ mm}$ from the intended path of the runway.

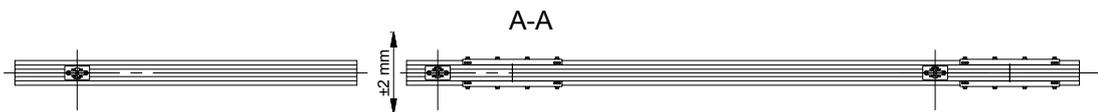

Telescoping bridges

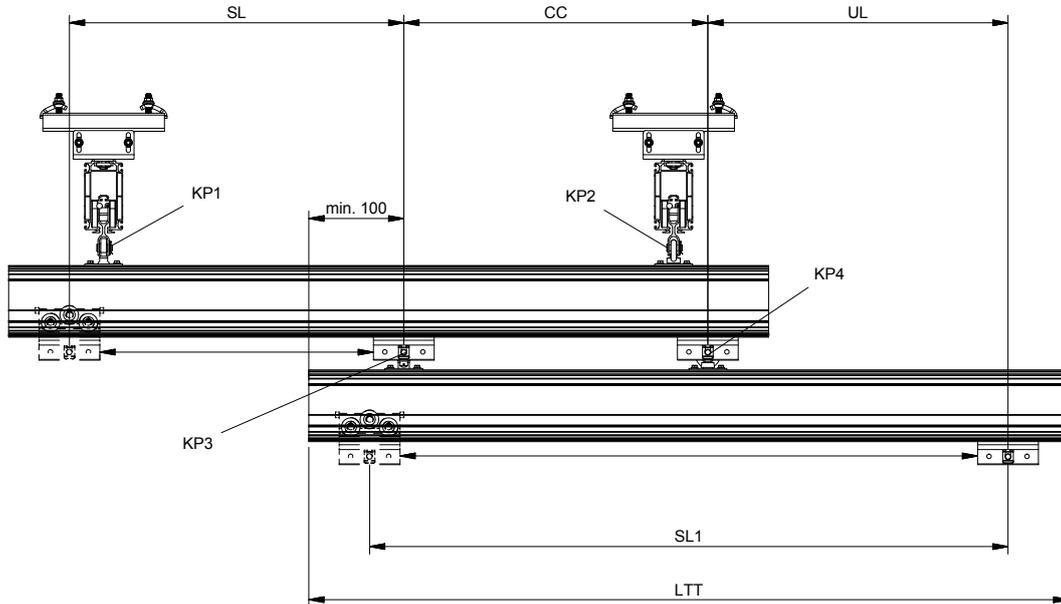

- SL = bridge stroke*
- SL1 = telescoping crane stroke*
- CC = distance between suspensions*
- UL = overhang*
- LTT = length telescoping bridge*
- KP = connection point*

INFORMATION

Contact Movomech if your application requires a telescoping bridge.

Suspensions D or F (see page 32) to be used with runway profiles.

Crane girder suspension C - ball joint to be used for KP1 single bridge.

Crane girder suspension C to be used for KP1 twin bridge.

Crane girder suspension A to be used for KP2.

Crane girder suspension C to be used for KP3.

Crane girder suspension A to be used for KP4.

An inverted trolley may be required for KP1 and/or KP3.

A double trolley may be required for KP4.

Triple track system

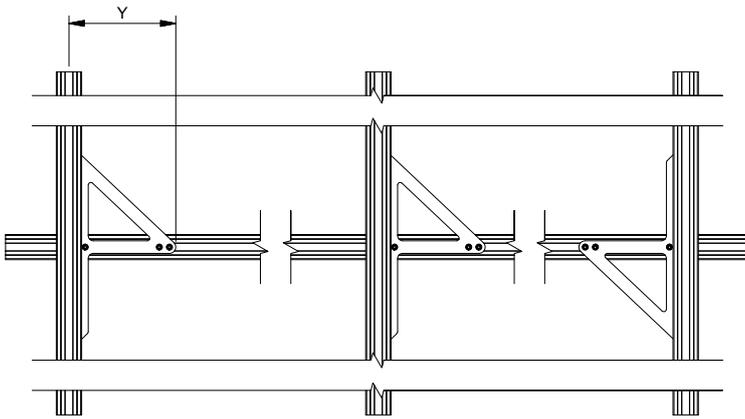
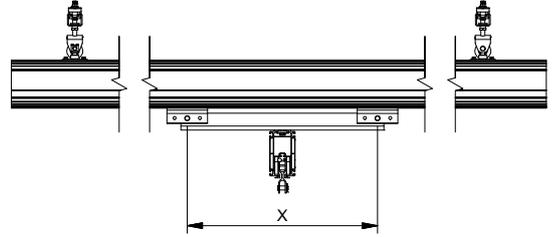
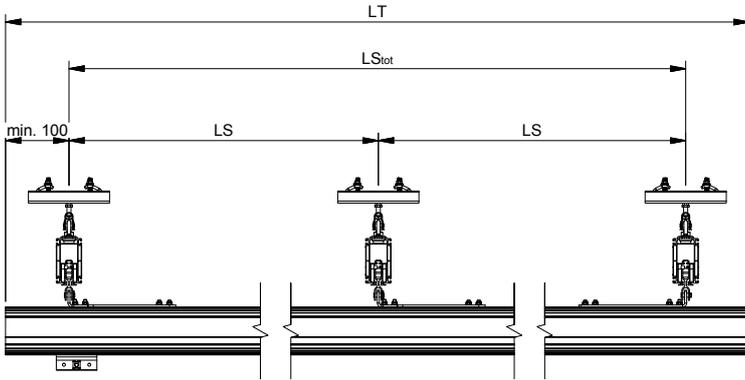

- LS = bridge span
- LS_{tot} = bridge total span
- LT = bridge length
- X = see "Triangular bracing" on page 46
- Y = see "Triangular bracing" on page 46

TOTAL INSTALLATION HEIGHT

Crane girder suspension

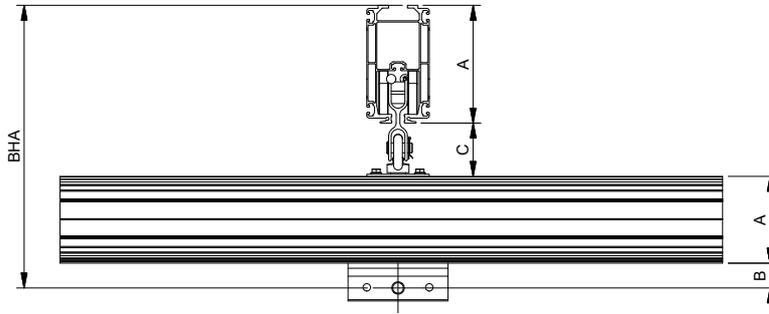

Triangular bracing

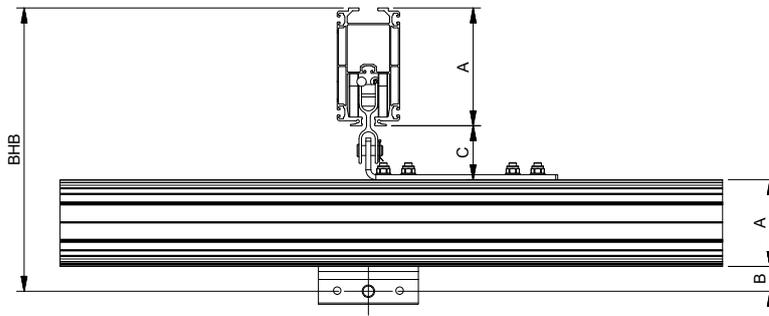

Space saving module

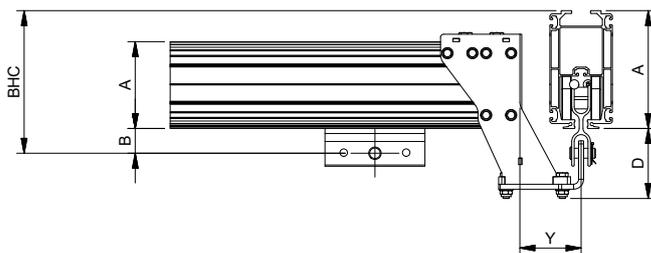

	A [mm]	B [mm]	C [mm]	D [mm]	Y [mm] (A)*	Y [mm] (B)*
30s						
PHB	90	41,5	90	N/A	N/A	N/A
LHB	90	39	87,5	139	105	95
50s						
PHB1	150	42,5	89	115,5	100	100
AHB140	140	40	86	113	100	100
AHB190	190	40	86	113	100	100
75s						
AHB3	210	43	95,5	109,5	147	137

* (A) Single bridge
(B) Double bridge

Chart: Total installation height

Profile, runway	Profile, bridge	BHA	BHB	BHC
30s				
PHB	PHB	312	N/A	N/A
	LHB	309	N/A	N/A
	PHB1	N/A	N/A	N/A
	AHB140	N/A	N/A	N/A
	AHB190	N/A	N/A	N/A
	AHB3	N/A	N/A	N/A
LHB	PHB	309	N/A	N/A
	LHB	307	307	129
	PHB1	370	N/A	N/A
	AHB140	358	N/A	N/A
	AHB190	N/A	N/A	N/A
	AHB3	N/A	N/A	N/A
50s				
PHB1	PHB	371	N/A	N/A
	LHB	368	N/A	N/A
	PHB1	432	432	205
	AHB140	419	419	193
	AHB190	469	469	193
	AHB3	500	N/A	N/A
AHB140	PHB	358	N/A	N/A
	LHB	355	N/A	N/A
	PHB1	419	419	193
	AHB140	406	406	180
	AHB190	456	456	180
	AHB3	487	N/A	N/A
AHB190	PHB	408	N/A	N/A
	LHB	405	N/A	N/A
	PHB1	469	469	243
	AHB140	456	456	230
	AHB190	506	506	230
	AHB3	537	N/A	N/A
75s				
AHB3	PHB	426	N/A	N/A
	LHB	423	N/A	N/A
	PHB1	490	N/A	N/A
	AHB140	478	N/A	N/A
	AHB190	528	N/A	N/A
	AHB3	559	559	253

LOAD CHARTS

The load charts show the maximum spacing for the suspensions in a runway or bridge for a given load.

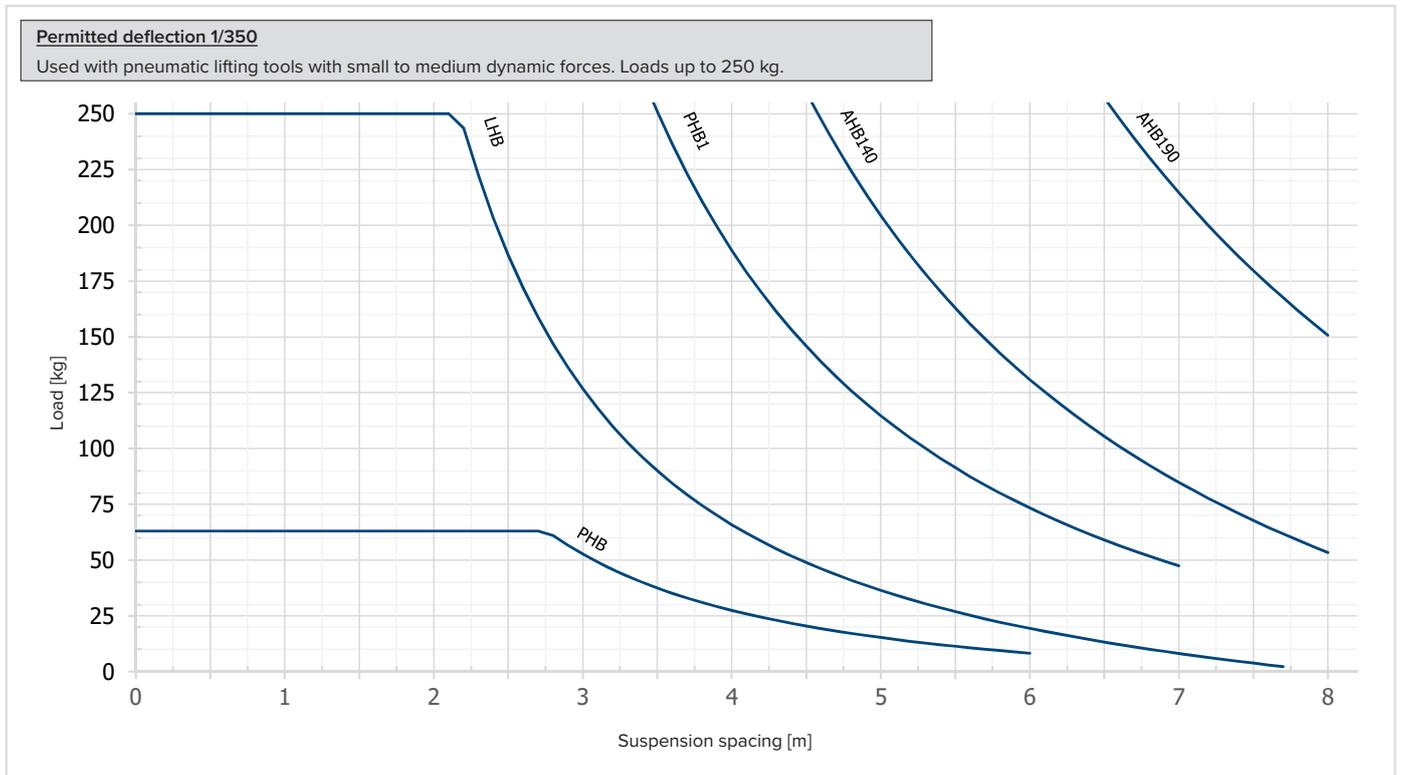
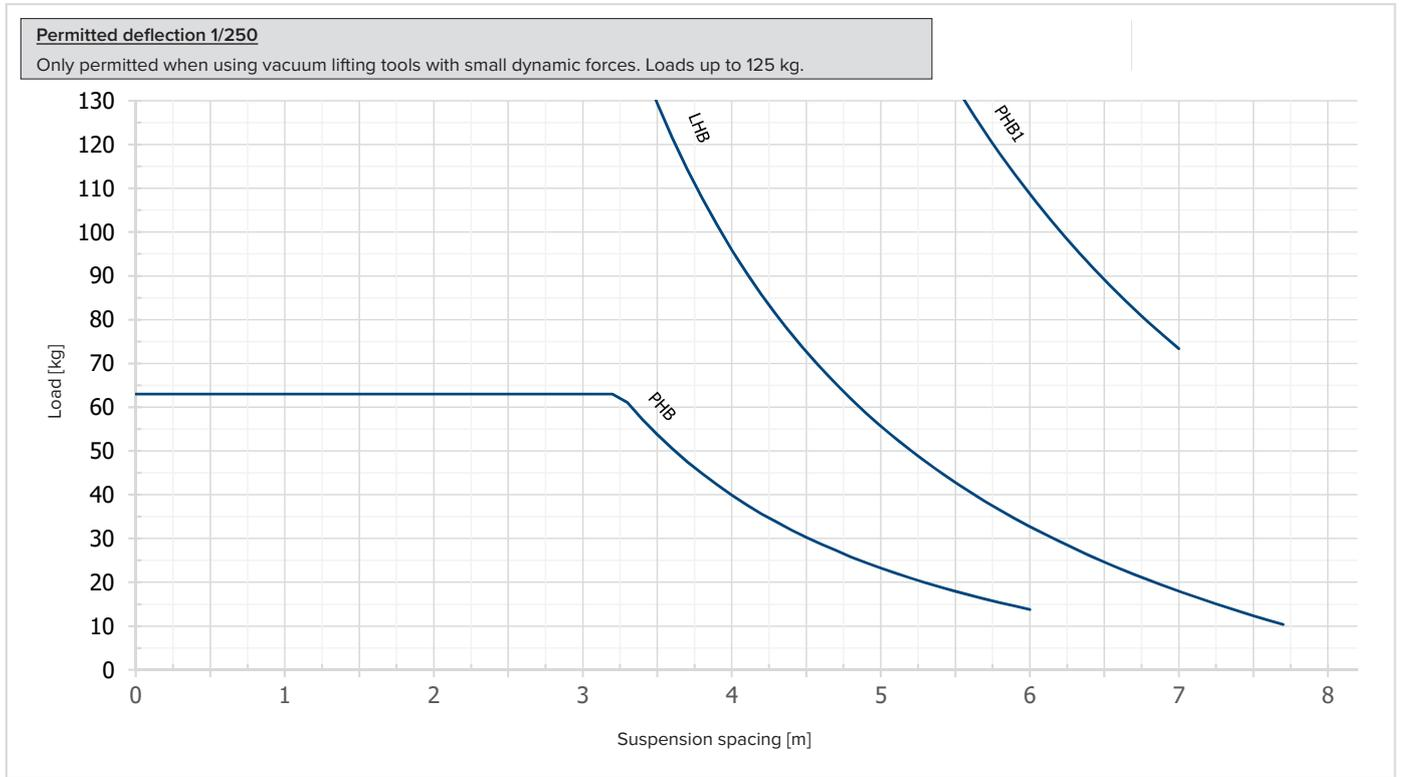

Permitted deflection 1/500

General use with all lifting applications with small to medium dynamic forces. Loads up to 500 kg.

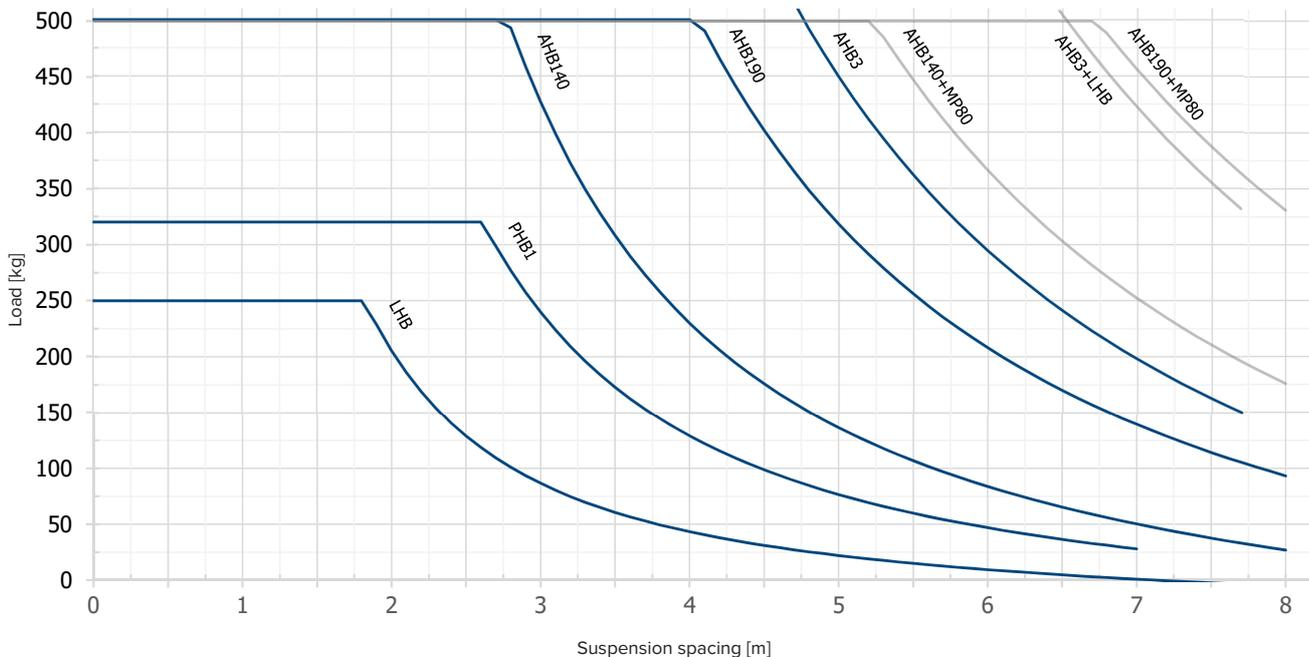

Permitted deflection 1/650

General use with all lifting applications with large dynamic forces. Loads up to 1000 kg.

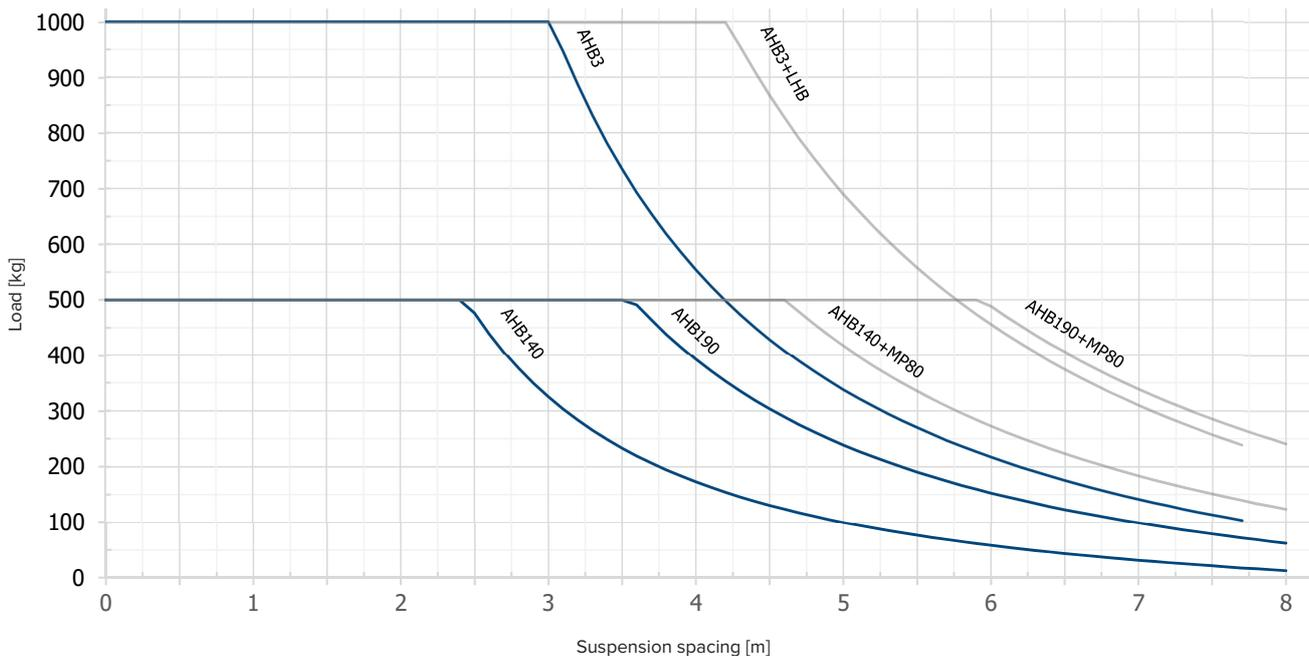

CLASSIFICATION OF OPERATIONS

Permitted operation classes for Mechrail considering fatigue strength.

		Total number for cyclic stress (fatigue life)			
		N1	N2	N3	N4
		Intermittent, non-regular operations with long periods of non-activity	Regular operations with intermittent use	Regular operations with continuous use	Regular operations with heavy continuous use
		< 200 000	200 000 - 600 000	600 000 - 2 000 000	> 2 000 000
Loadings					
S0	Very small changes of loads. Gentle operational use.	B1	B2	B3	B4
S1	Small changes of loads. Careful operational use.	B2	B3	B4	B5
S2	Average change of loads.	B3	B4	B5	B6
S3	Large changes of loads. Heavy operational use.	B4	B5	B6	B6

The following reduction factor must be observed when calculating the permitted capacity for trolleys and suspension components:

Trolley	B1	B2	B3	B4	B5	B6	
without any profile joints	1.0	1.0	1.0	1.0	0.8	0.7	} x the capacity
with profile joints	1.0	1.0	0.9	0.75	0.65	0.55	
Suspension component	B1	B2	B3	B4	B5	B6	
	1.0	1.0	1.0	1.0	0.8	0.7	} x the capacity

SAFETY WIRE

For suspension

INFORMATION

Safety wires are used to secure the runway to the overhead beams.

This is recommended when only two suspensions are holding a runway length, e.g. with a transverse steel beam where an added suspension cannot be fitted, as well as for cases with critical loads.

The length of the wire is to be adapted to each case.

See also "Safety wire for suspensions" on page 37.

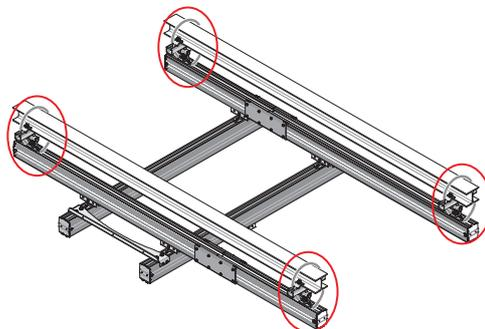

Longitudinal steel beam, suspension safety wire fitted

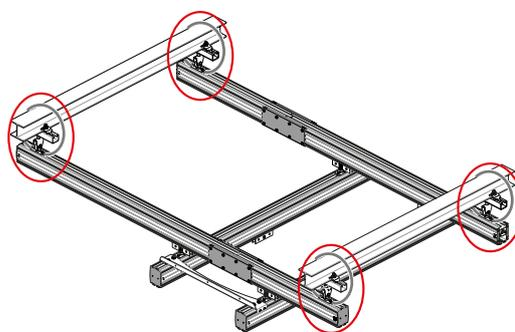

Transverse steel beam, suspension safety wire fitted

For bridge

INFORMATION

A safety wire is used for a bridge to secure the crane girder suspension to the trolley.

Movomech recommends that these are used with single bridges.

See also the section "Safety wire for bridges" on page 49.

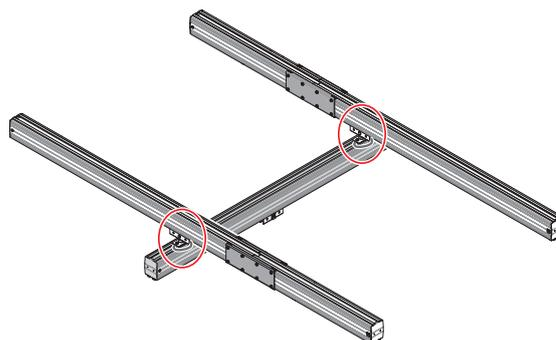

Safety wire for bridge fitted

COMPONENTS

CRANE SYSTEM PROFILES

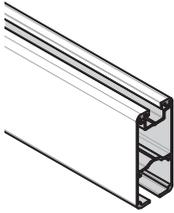
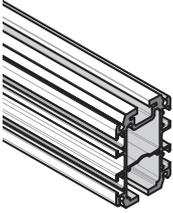
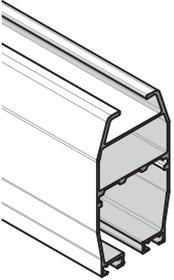
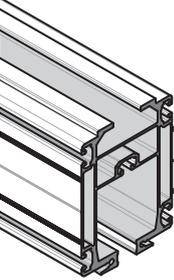
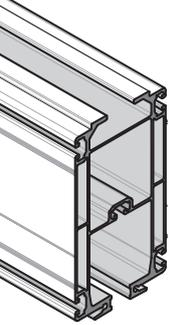
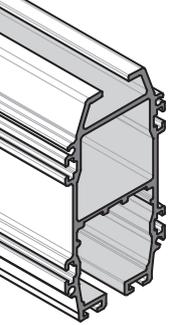
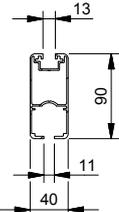
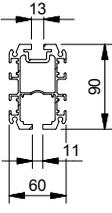
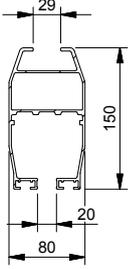
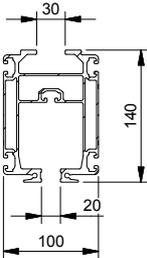
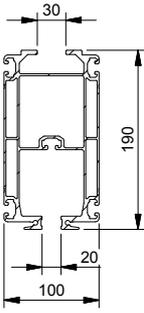
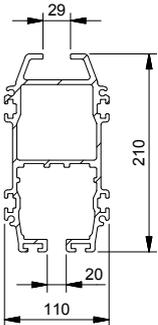
30s		50s			75s						
PHB	LHB	PHB1	AHB140	AHB190	AHB3						
											
											
m: 1,6 kg/m I _x : 56 cm ⁴ I _y : 14 cm ⁴ W _x : 11 cm ³ W _y : 3 cm ³	m: 3,7 kg/m I _x : 123 cm ⁴ I _y : 51 cm ⁴ W _x : 25 cm ³ W _y : 17 cm ³	m: 4,0 kg/m I _x : 325 cm ⁴ I _y : 137 cm ⁴ W _x : 43 cm ³ W _y : 27 cm ³	m: 7,0 kg/m I _x : 578 cm ⁴ I _y : 313 cm ⁴ W _x : 83 cm ³ W _y : 63 cm ³	m: 8,2 kg/m I _x : 1254 cm ⁴ I _y : 394 cm ⁴ W _x : 128 cm ³ W _y : 79 cm ³	m: 11,2 kg/m I _x : 1767 cm ⁴ I _y : 598 cm ⁴ W _x : 168 cm ³ W _y : 108 cm ³						
#	L [m]	#	L [m]	#	L [m]	#	L [m]	#	L [m]	#	L [m]
742161	1	730192	1	737510	1	743171	1	743181	1	730408	1
742162	2	730193	2	737511	2	743172	2	743182	2	730409	2
746163	3	730194	3	737512	3	743173	3	743183	3	730410	3
742164	4	730195	4	737513	4	743174	4	743184	4	730411	4
742165	5	730196	5	737514	5	743175	5	743185	5	730412	5
742166	6	730197	6	737515	6	743176	6	743186	6	730413	6
		730198	7	738829	7	743177	7	743187	7	730414	7
		737218	7.7			743178	8	743188	8	737217	7.7

Curved section PHB1

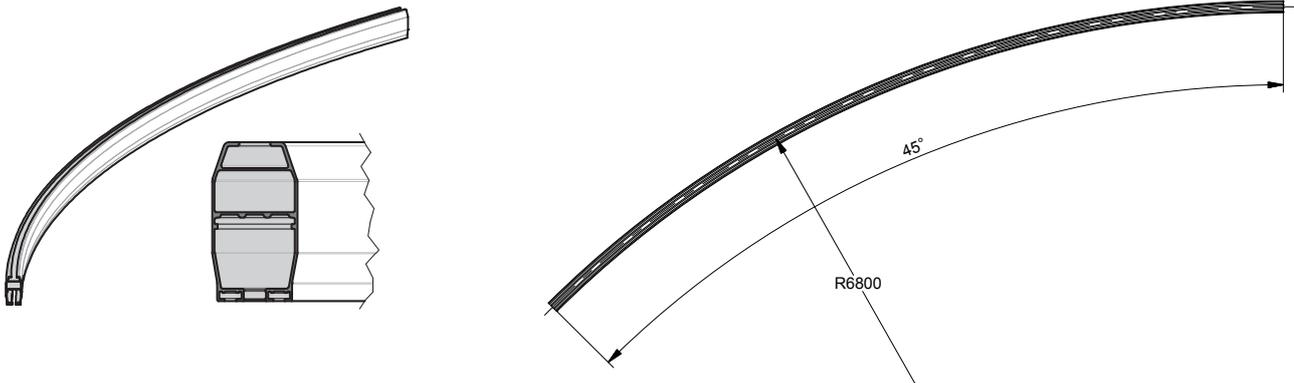

#		m [kg]	I_x [cm ⁴]	I_y [cm ⁴]	W_x [cm ³]	W_y [cm ³]	Note
50s							
740407	PHB1	21.3	325	137	43	27	

INFORMATION

Other type of curved sections on request. Contact Movomech.

Reinforcing profile - combination AHB140/190 + MP80

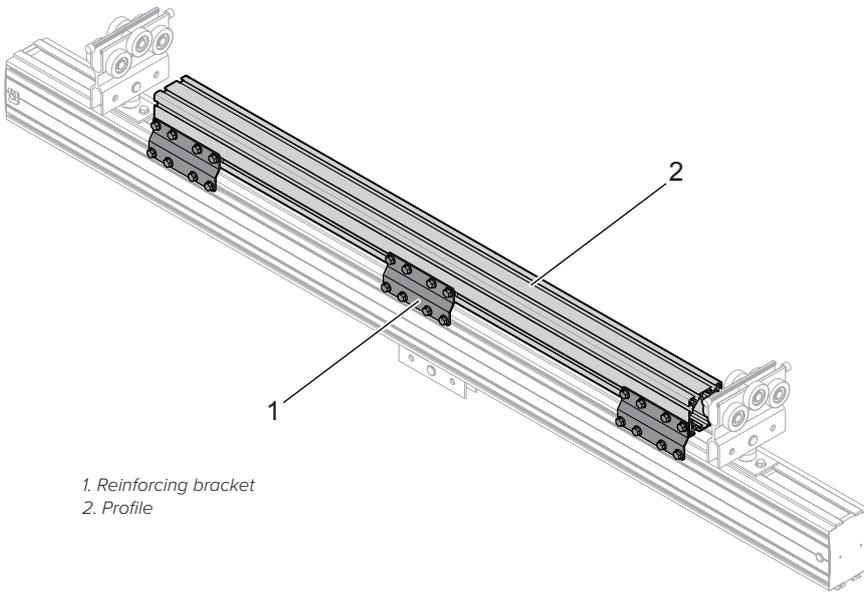

1. Reinforcing bracket
2. Profile

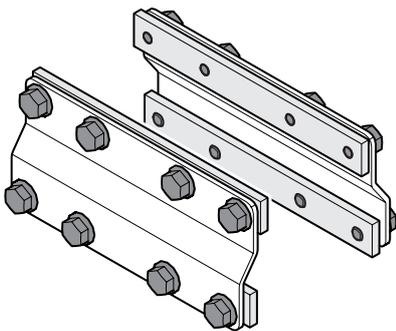
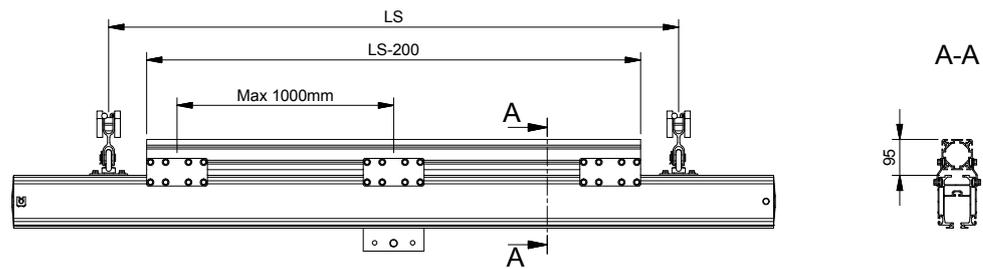

Reinforcing bracket

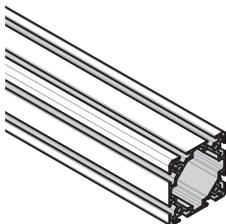

Profile MP80

Combination	I_x [cm ⁴]	m [kg/m]	Note
AHB140 + MP80	2137	10.6	
AHB190 + MP80	3642	11.8	

INFORMATION
A reinforcing profile is used to reduce the deflection of long spans.

#	Note	
50s		
743685	Reinforcing bracket	
730188	Profile MP80	Sold by length (Lmax=6 m)

Reinforcing profile - combination AHB3 + LHB

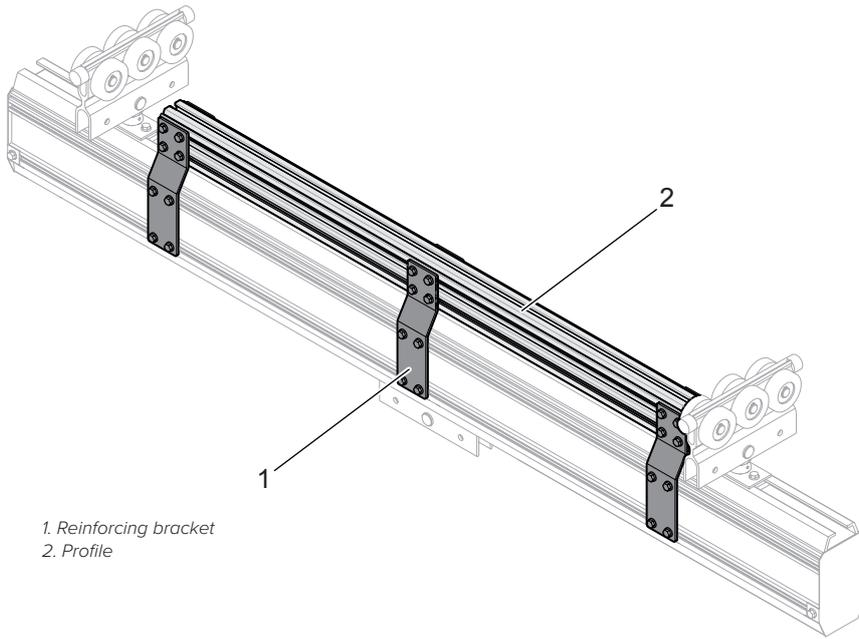

1. Reinforcing bracket
2. Profile

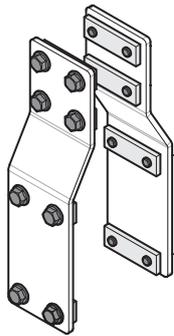
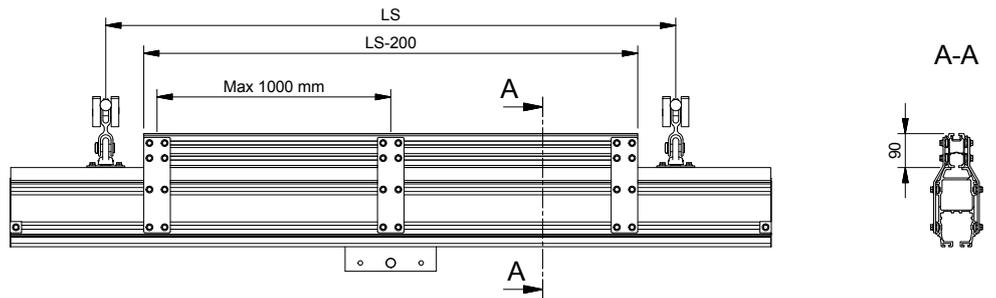

Reinforcing bracket

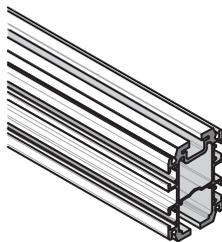

Profile LHB

Combination	I_x [cm ⁴]	m [kg/m]	Note
AHB3 + LHB	3500	15.3	

INFORMATION

A reinforcing profile is used to reduce the deflection of long spans.

#	L [m]	Note
75s		
743871		Reinforcing bracket
730192	1	Profile LHB
730193	2	Profile LHB
730194	3	Profile LHB
730195	4	Profile LHB
730196	5	Profile LHB
730197	6	Profile LHB
730198	7	Profile LHB
737218	7.7	Profile LHB

SUSPENSIONS

(A) Short

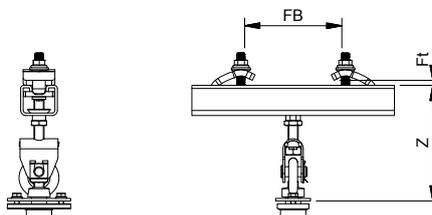
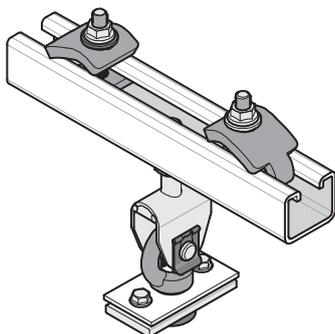

#	Load [kg] ↓	FB [mm]	F _{t max} [mm]	Z [mm]	m [kg]	Note
30s						
733203	300	55 - 220	15	184 ±12	3.2	
733204	300	55 - 320	15	184 ±12	3.9	
50s						
732765	600	55 - 220	15	183 ±12	3.8	
733200	600	55 - 320	15	183 ±12	4.5	
75s						
732244	1200	90 - 310	15	200 ±10	5.8	

(B) Intermediate

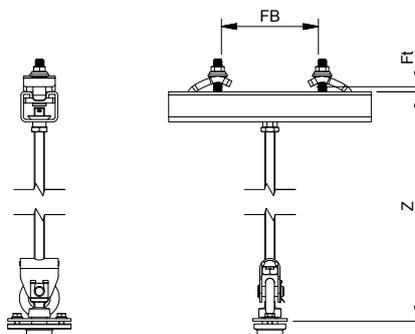
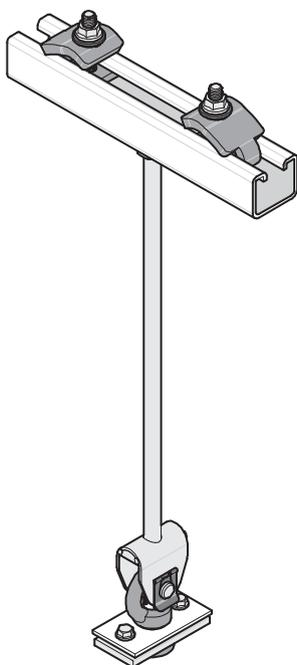

#	Load [kg] ↓	FB [mm]	F _{t max} [mm]	Z [mm]	m [kg]	Note
30s						
730245	300	55 - 220	15	184 - 600 ±12*	3.2	
730246	300	55 - 320	15	184 - 600 ±12*	3.9	
50s						
730394	600	55 - 220	15	183 - 600 ±12*	3.8	
730395	600	55 - 320	15	183 - 600 ±12*	4.5	
75s						
730452	1200	90 - 310	15	200 - 600 ±10*	5.8	

* to be stated when ordering

(C) Long

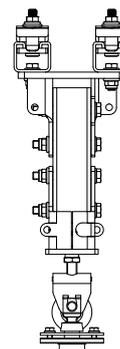
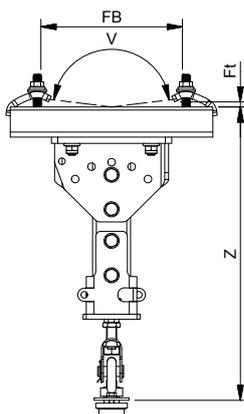
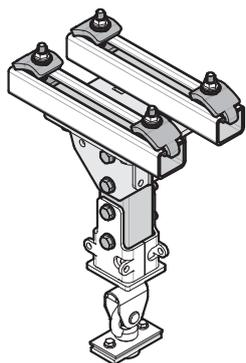

#	Load [kg] ↓	FB [mm]	F _{t max} [mm]	Z [mm]	V [°]	m [kg]	Note
30s							
743873	300	45 - 220	15	470 - 2000 ±12*	±45	13.1	
743874	300	45 - 320	15	470 - 2000 ±12*	±45	13.7	
50s							
743600	600	45 - 220	15	470 - 2000 ±12*	±45	13.7	
743601	600	45 - 320	15	470 - 2000 ±12*	±45	14.3	
75s							
743875	1200	45 - 220	15	490 - 2000 ±12*	±45	13.9	
743876	1200	45 - 320	15	490 - 2000 ±12*	±45	14.5	
* to be stated when ordering							

Suspension cross brace (C)

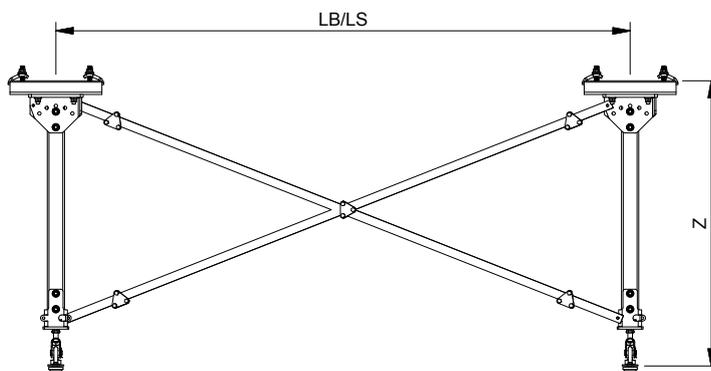
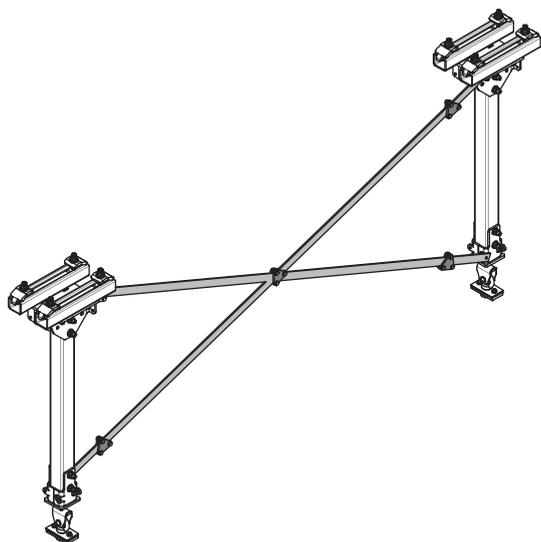

#	m [kg]	Note
743918	21	

INFORMATION

A cross brace is recommended at Z > 1000 mm and/or in case of large dynamic forces in the crane system.

Cross braces are supplied as kits to fit in between two suspensions. Max LB/LS = 7.5 m.

The cross braces may have to be cut to length when used together with a combination of a short LB/LS and a short Z.

(D) Tight

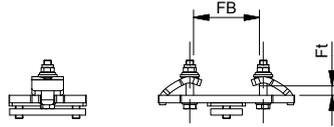
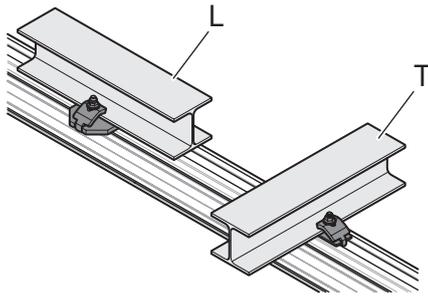

INFORMATION

Cannot be used together with space saving module for bridge.

The overhead beams mustn't exceed the tolerance ± 2 mm in the horizontal level.

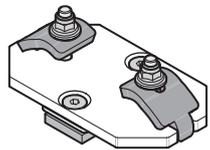

L

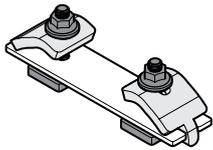

T

#		Load [kg] ↓	FB [mm]	F _{t,max} [mm]	Z [mm]	m [kg]	Note
30s							
743841	L	300	70 - 220*	15	12	2.7	
743842	T	300	45 - 300*	15	5	1	
50s							
743843	L	600	70 - 220*	15	17	3.4	
743844	T	600	45 - 300*	15	5	1.3	
75s							
743845	L	1200	90 - 220*	15	15	4.7	
743846	T	1200	55 - 300*	15	5	1.9	
* to be stated when ordering							

(E) With spherical nut

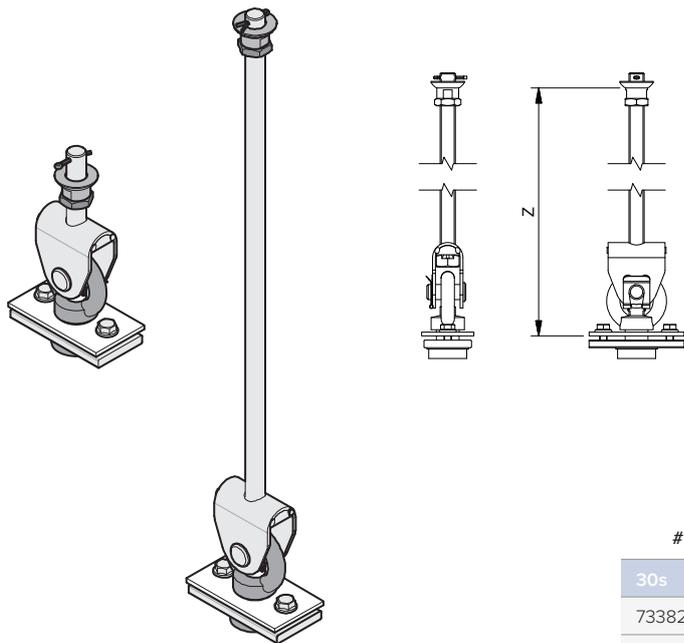

INFORMATION
 When fitting a spherical nut suspension, a hole must be drilled and countersunk as per the image below.

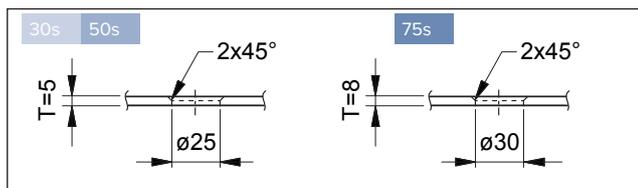

#	Load [kg]	Ø	Z [mm]	m [kg]	Note
30s					
733829	300	25	138 ±12	1	
732035	300	25	130 - 560*	2	
50s					
733830	600	25	137 ±12	1	
731734	600	25	130 - 560*	2	
75s					
733831	1200	30	161 ±12	1	
732562	1200	30	170 - 560*	2	
* to be stated when ordering					

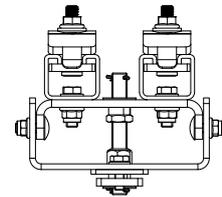
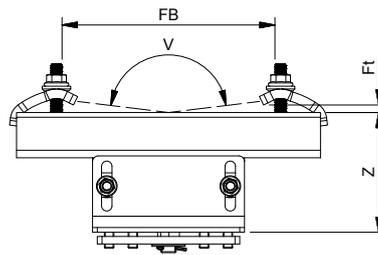
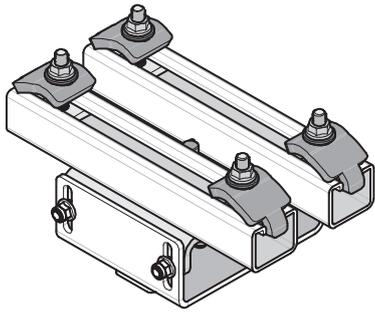
(F) Tight, adjustable

#	Load [kg] ↓ / ↑	FB [mm]	$F_{t,max}$ [mm]	Z [mm]	V [°]	m [kg]	Note
30s							
743884	300 / 150	45 - 220	15	153 ±12	±7	10.7	
743885	300 / 150	45 - 320	15	153 ±12	±7	11.3	
50s							
743604	600 / 300	45 - 220	15	127 ±12	±7	11.2	
743605	600 / 300	45 - 320	15	127 ±12	±7	12.3	
75s							
743886	1200 / 600	45 - 220	15	129 ±12	±7	11.4	
743887	1200 / 600	45 - 320	15	129 ±12	±7	12	

INFORMATION

Cannot be used together with a space saving module for bridge.

SAFETY WIRE FOR SUSPENSIONS

30s

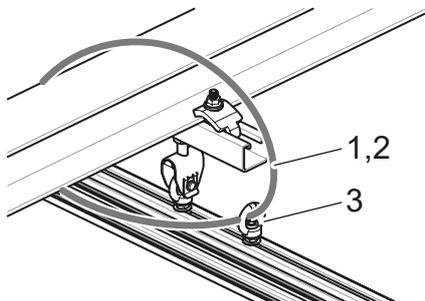

Crane girder suspension



Wire lock (2x)



Wire

50s

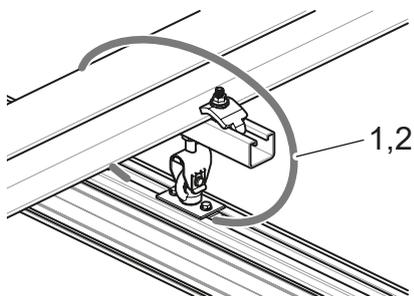

Wire lock (2x)



Wire

75s

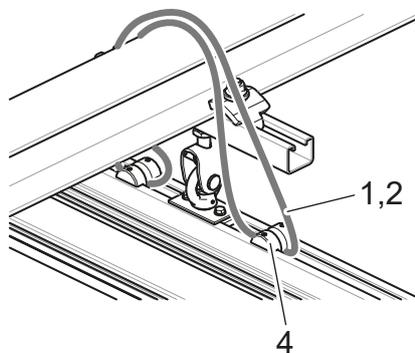

Wire roll (2x)



Wire lock (2x)



Wire

- 1. Wire
- 2. Wire lock
- 3. Crane girder suspension
- 4. Wire roll

INFORMATION
See also the section "Safety wire" on page 27.

#	Quantity	Description	Ø	Note
30s				
740571	L	Wire	5	State length when ordering
740569	2	Wire lock		
730224	1	Crane girder suspension		
50s				
740858	L	Wire	7	State length when ordering
740859	2	Wire lock		
75s				
740858	L	Wire	7	State length when ordering
740859	2	Wire lock		
740872	2	Wire roll		

TROLLEYS

(A) Single trolley

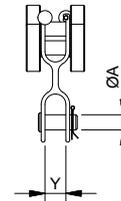
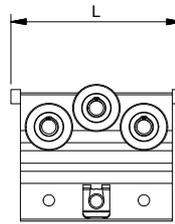
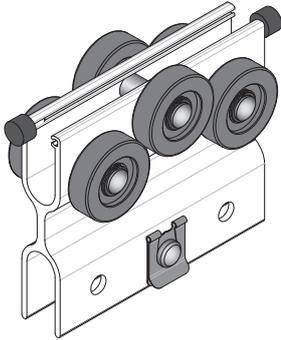

#	Load [kg]		L	Y	ØA	m [kg]	Note
	↓ / ↑						
30s							
	PHB	LHB					
730200	63 / 32	125 / 63	140	22	12	0.5	
50s							
	PHB1	AHB140/190					
730323	160 / 80	250 / 125	180	22	16	1.2	Ø15 mm rubber bumper
730364	160 / 80	250 / 125	210	22	16	1.2	Ø30 mm rubber bumper
75s							
	AHB3						
730442	500 / 250		250	28	20	2.8	

(B) Inverted trolley

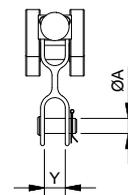
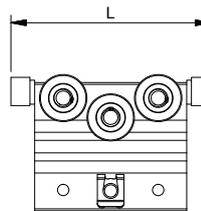
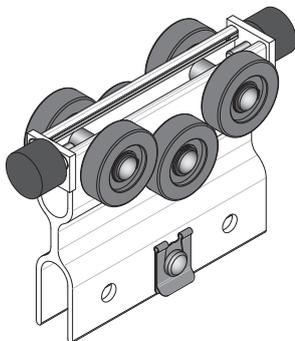

#	Load [kg]		L	Y	Ø _s	m [kg]	Note
	↓ / ↑						
30s							
	PHB	LHB					
733655	32 / 63	63 / 125	140	22	12	0.5	
50s							
	PHB1	AHB140/190					
732155	80 / 160	125 / 250	210	22	16	1.2	
75s							
	AHB3						
735823	250 / 500		250	28	20	2.8	

(C) Double trolley

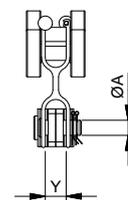
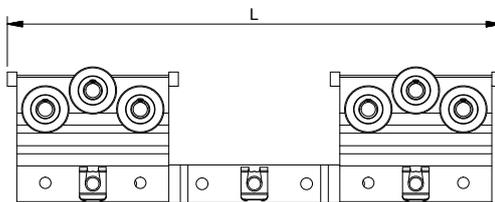
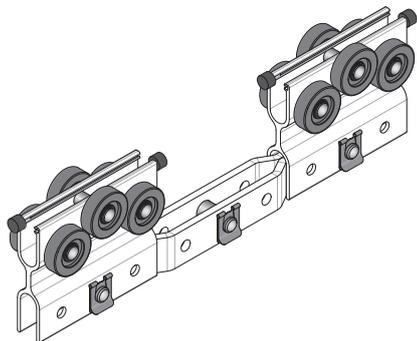

#	Load [kg]		L	Y	ØA	M _v [Nm]	m [kg]	Note
	↓ / ↑							
30s			LHB					
743048	250 / 125		480	22	20		2.7	
50s			PHB1 AHB140/190					
743039	320 / 160	500 / 250	520	22	20		3.8	
743040	320 / 160	500 / 250	637	22	20	55	4.5	With nose wheel
75s			AHB3					
743041	1000 / 500		700	22	20		6.6	

(E) Trolley with nose wheel

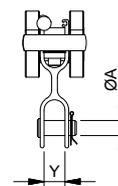
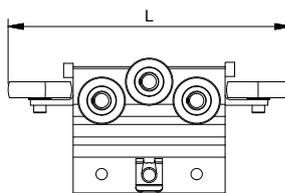
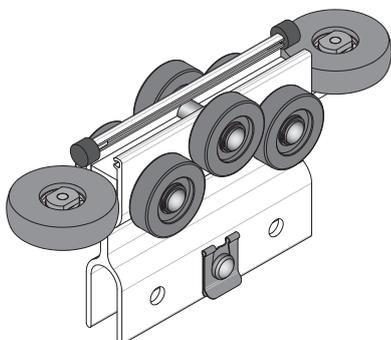

#	Load [kg]		L	Y	ØA	M _v [Nm]	m [kg]	Note
	↓ / ↑							
30s			LHB					
730582	125 / 63		390	22	12	40	1.3	
730583	125 / 63		590	22	12	70	1.7	
50s			PHB1 AHB140/190		PHB1 AHB140/190			
737285		250 / 125	294	22	16		60	1.4
740230	160 / 80		294	22	16	30	60	1.4 For curved sections
737284		250 / 125	294	22	16	30	60	1.4 For curved sections
737522		125 / 250	294	22	16		60	1.4 Inverted
75s			AHB3					
737199	500 / 250		468	28	20	85	3	

END STOPS

(A) Standard

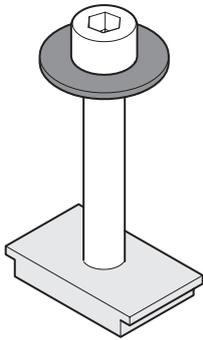

PHB

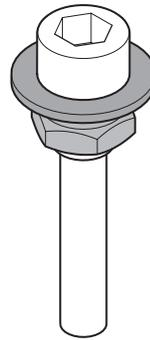
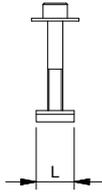

LHB

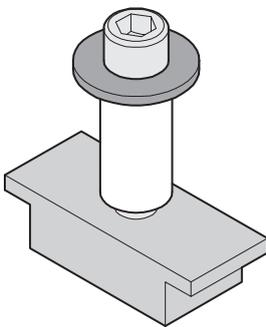
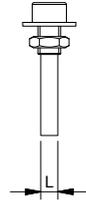

PHB1

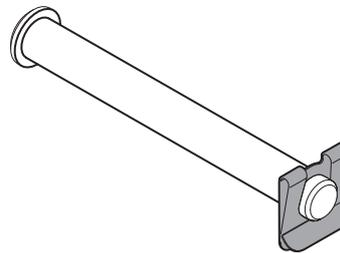
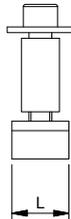

AHB140/190

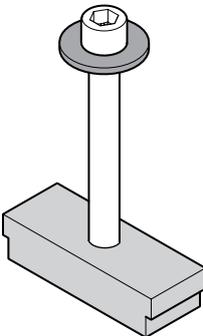
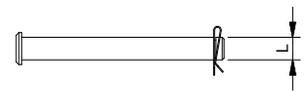

AHB3

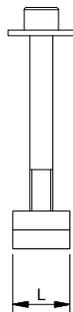

INFORMATION
ATTENTION! End stops must always be fitted in the runway and in the bridge.

#		L	m [kg]	Note
30s				
742168	PHB	20	0.2	
730220	LHB	9	0.1	
50s				
737605	PHB1	30	0.25	
743606	AHB140/190	12	0.1	
75s				
730421	AHB3	30	0.5	

(B) Fitted from below

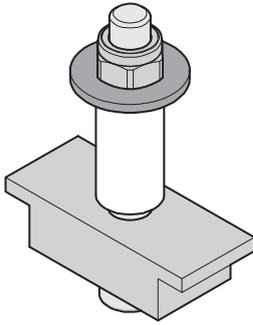

PHB1

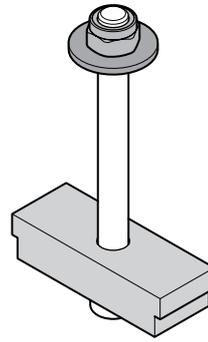
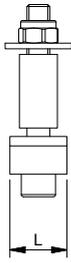

AHB3

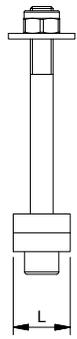

INFORMATION

ATTENTION! End stops must always be fitted in the runway and in the bridge.

#		L	m [kg]	Note
50s				
737606	PHB1	30	0.3	
75s				
730641	AHB3	30	0.5	

END COVERS

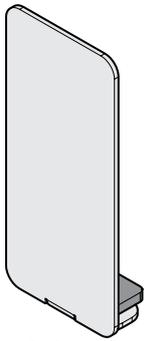

PHB

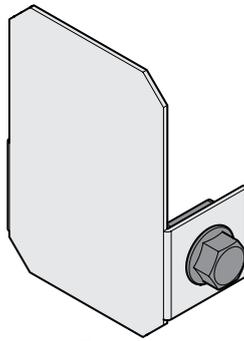

LHB

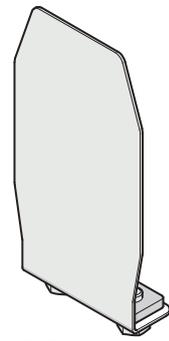

PHB1

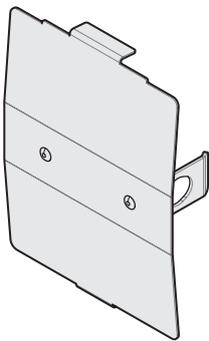

AHB140

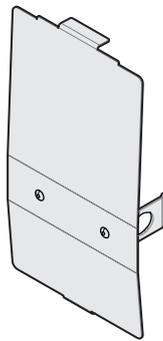

AHB190

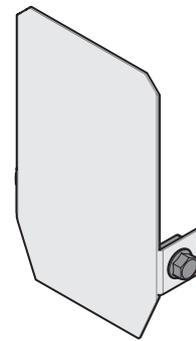

AHB3

#		m [kg]	Note
30s			
736699	PHB	0.15	
730211	LHB	0.15	
50s			
737569	PHB1	0.2	
743607	AHB140	0.1	
743608	AHB190	0.2	
75s			
730416	AHB3	0.3	

JOINT SETS

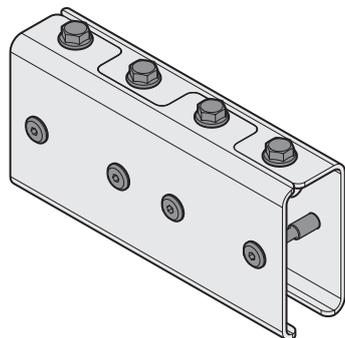

PHB

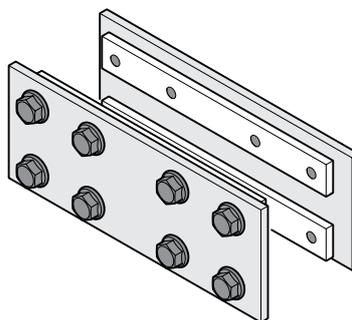
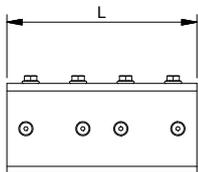

LHB

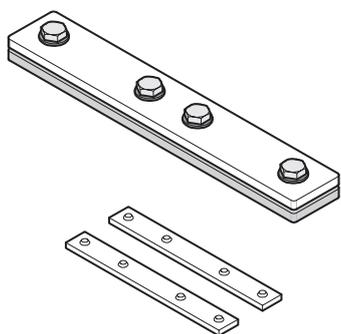
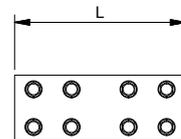

PHB1

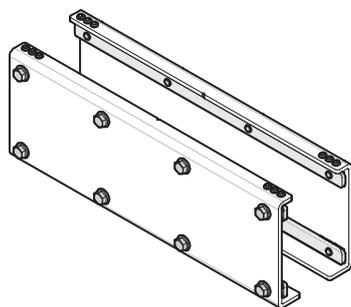
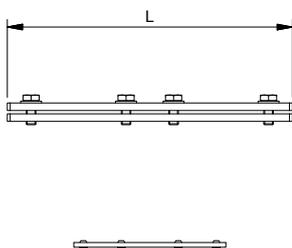

AHB140, AHB190

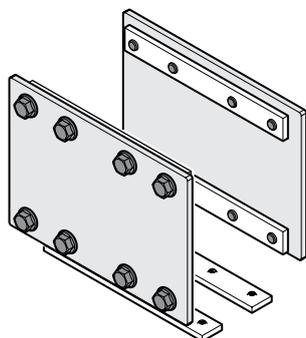
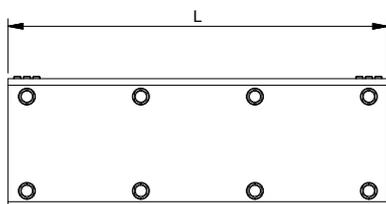

AHB3

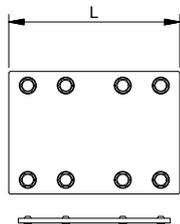

#		L [mm]	m [kg]	Note
30s				
742167	PHB	200	1.6	
730212	LHB	180	1.7	
50s				
737609	PHB1	300	1.7	
739999	PHB1	300	1.7	For curved sections
743657	AHB140	400	7.1	
743658	AHB190	400	8.6	
75s				
730418	AHB3	180	2.5	

CRANE GIRDER SUSPENSIONS

(A)

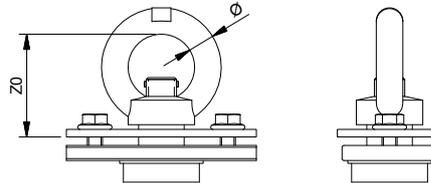
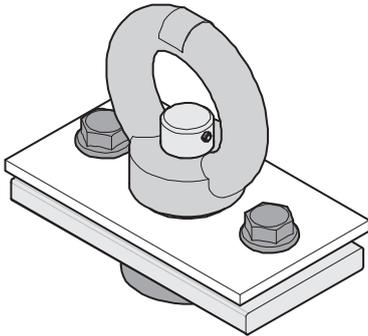

#	Load [kg] ↓	Z0	Ø	m [kg]	Note
30s					
730224	300	55	12	0.25	
50s					
730379	600	55	12	0.85	
75s					
730424	1200	62	16	1.2	

(B)

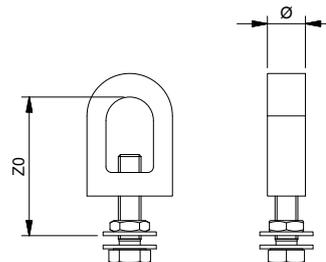
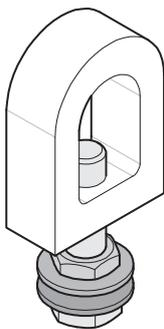

INFORMATION
 (B) fits the AHB3 trolley and various trolleys with pins Ø20 mm (e.g. ABUS and DEMAG).

#	Load [kg] ↓	Z0	Ø	m [kg]	Note
30s					
730540	300	69	20	0.3	

(C)

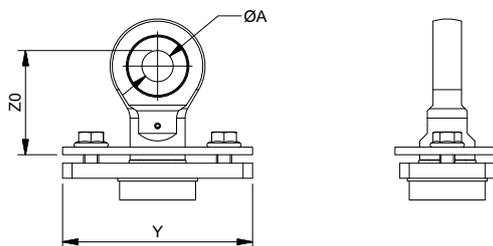
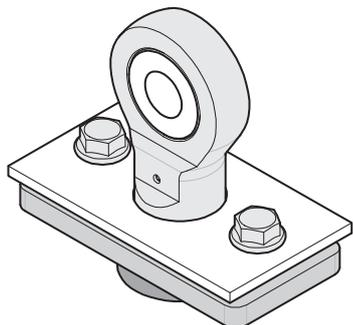

INFORMATION
 (C) has a play-free design, and is used in case of upwards-directed forces.

#	Load [kg] ↓ / ↑	Z0	Y	ØA	m [kg]	Note
50s						
743609	600 / 300	55	100	16	0.9	
743610	600 / 300	55	100	16	0.9	Ball joint
743659	600 / 300	55	100	20	0.8	

TRIANGULAR BRACING

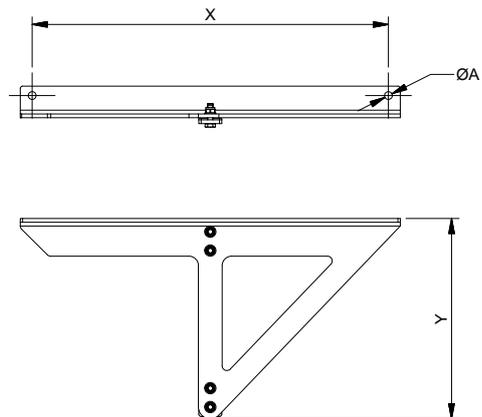
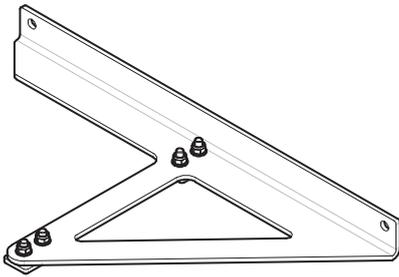

#		Load [kg] ↓ / ↑	LS	ØA	X	Y	m [kg]	Note
30s								
740434	LHB	300 / 150	- 2000	12	250	157	1.3	
740435	LHB	300 / 150	(2000) - 4000	12	500	288	3	
740436	LHB	300 / 150	(4000) - 6000	12	750	418	4.5	
740437	LHB	300 / 150	(6000) - 8000	12	1000	538	6	
50s								
743617		600 / 300	- 3000	16	375	221	5	
740438		600 / 300	(3000) - 4000	16	500	303	6.5	
740439		600 / 300	(4000) - 6000	16	750	421	9.3	
740440		600 / 300	(6000) - 8000	16	1000	552	12.9	
740441		600 / 300	(8000) - 10000	16	1250	667	16	
75s								
740442		1200 / 600	- 4000	20	500	310	8.3	
740443		1200 / 600	(4000) - 6000	20	750	448	13.6	
740444		1200 / 600	(6000) - 8000	20	1000	573	18.3	
740445		1200 / 600	(8000) - 10000	20	1250	696	23.1	

INFORMATION

Recommended for triple track runways.
ATTENTION! Sold individually.

SPACE SAVING MODULES

(A) Single bridge

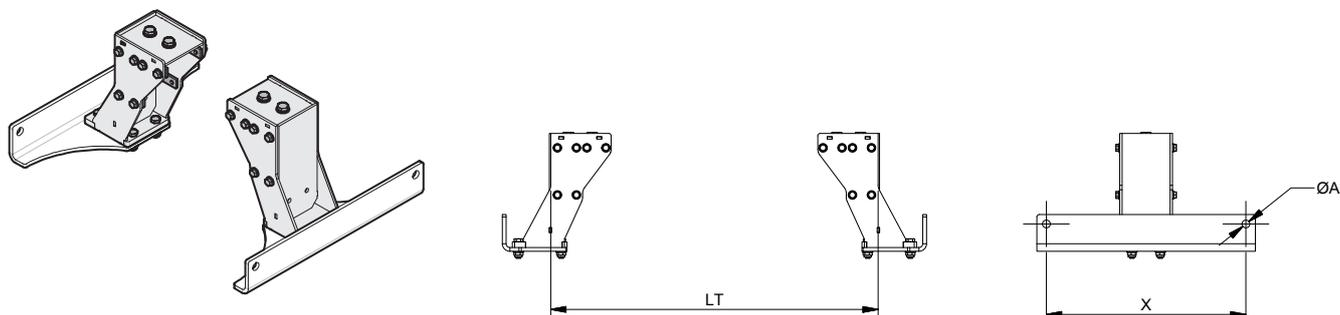

#		Load [kg] ↓ / ↑	LS	ØA	X	LT	m [kg]	Note
30s								
740156	LHB	300 / 150	- 3000	12	330	LS-210	13	
740158	LHB	300 / 150	(3000) - 6000	12	690	LS-210	22	
740160	LHB	300 / 150	(6000) - 7910	12	930	LS-210	27	
50s								
743189	PHB1	600 / 300	- 3000	16	420	LS-200	18	
743190	PHB1	600 / 300	(3000) - 6000	16	670	LS-200	22.5	
743191	PHB1	600 / 300	(6000) - 6800	16	920	LS-200	26.5	
743618	AHB140	600 / 300	- 3000	16	420	LS-200	18.5	
743619	AHB140	600 / 300	(3000) - 6000	16	670	LS-200	23	
743620	AHB140	600 / 300	(6000) - 8000	16	920	LS-200	27	
743621	AHB190	600 / 300	- 3000	16	420	LS-200	19.5	
743622	AHB190	600 / 300	(3000) - 6000	16	670	LS-200	23.5	
743623	AHB190	600 / 300	(6000) - 8000	16	920	LS-200	28	
75s								
740138	AHB3	1200 / 600	- 3000	20	500	LS-294	20	
740140	AHB3	1200 / 600	(3000) - 6000	20	671	LS-294	24	
740142	AHB3	1200 / 600	(6000) - 7700	20	910	LS-294	30	

(B) Twin bridge

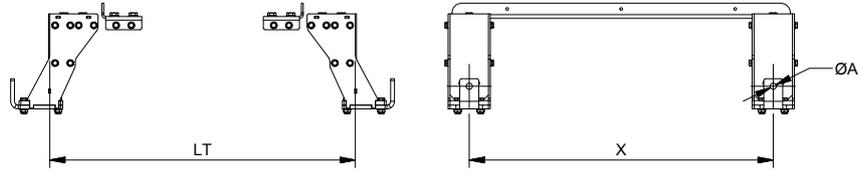
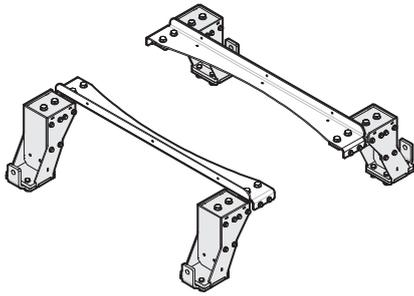

#		Load [kg] ↓ / ↑	LS	ØA	X	LT	m [kg]	Note
30s								
740146	LHB	300 / 150	250 - 7890	12	800	LS-190	23	
740155	LHB	300 / 150	250 - 7890	12	1000	LS-190	25	
50s								
743192	PHB1	600 / 300	250 - 6800	16	800	LS-200	31	
743624	AHB140	600 / 300	660 - 8000	16	800	LS-200	36	
743625	AHB140	600 / 300	660 - 8000	16	1000	LS-200	37.5	
743626	AHB140	600 / 300	660 - 8000	20	800	LS-200	36	
743627	AHB140	600 / 300	660 - 8000	20	1000	LS-200	37.5	
743628	AHB190	600 / 300	660 - 8000	16	800	LS-200	37.5	
743629	AHB190	600 / 300	660 - 8000	16	1000	LS-200	39	
743630	AHB190	600 / 300	660 - 8000	20	800	LS-200	37.5	
743631	AHB190	600 / 300	660 - 8000	20	1000	LS-200	39	
75s								
740130	AHB3	1200 / 600	250 - 7970	20	800	LS-274	20	
740137	AHB3	1200 / 600	250 - 7970	20	1000	LS-274	24	

SAFETY WIRE FOR BRIDGES

30s

(B) Single trolley, to be installed post commissioning

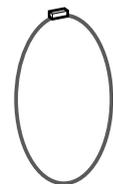
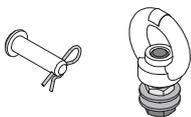
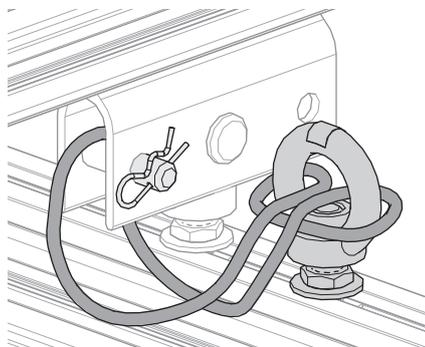

INFORMATION

A safety wire is used for a bridge to secure the crane girder suspension to the trolley. Movomech recommends that these are used with single bridges.

Supplied as a kit. Secures one crane girder suspension.

See also the section "Safety wire" on page 27.

(C) Double trolley

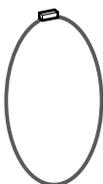
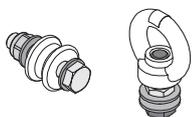
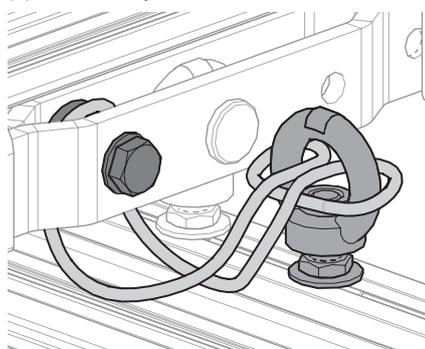

#		Ø	Note
30s			
740855	(B) Single trolley	145	To be installed post commissioning
743051	(C) Double trolley	145	

50s

(A) Single trolley

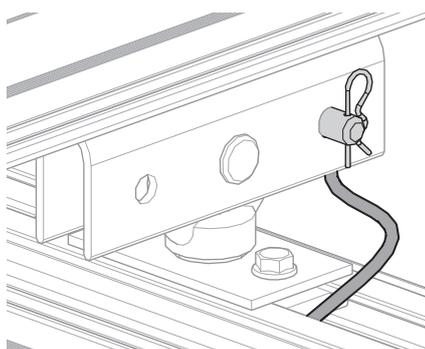

(B) Single trolley, to be installed post commissioning

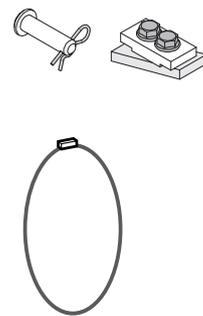
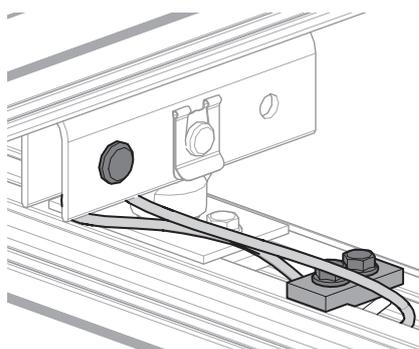

(C) Double trolley

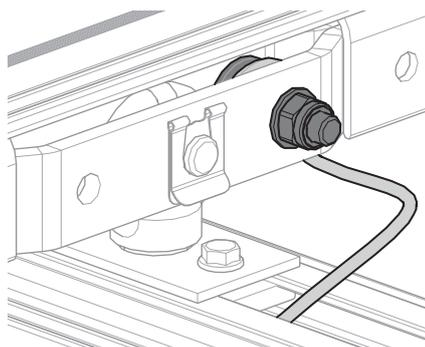

#		Ø	Note
50s			
740852	(A) Single trolley	145	
740856	(B) Single trolley	145	To be installed post commissioning
743052	(C) Double trolley	145	

75s

(B) Single trolley, to be installed post commissioning

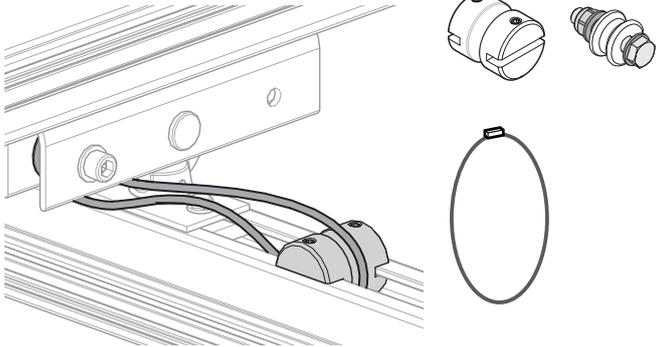

(C) Double trolley

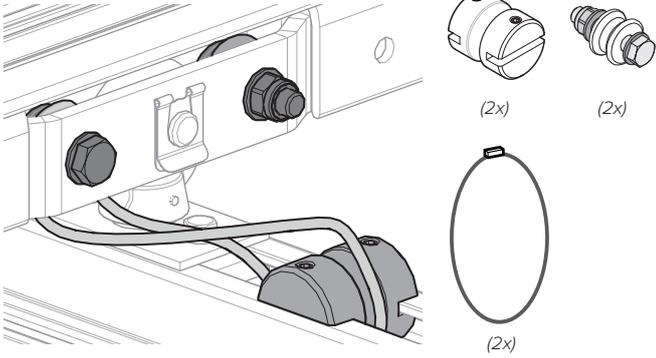

#		Ø	Note
75s			
740563	(B) Single trolley	145	To be installed post commissioning
743056	(C) Double trolley	145	

DISTANCES FOR DOUBLE CRANES

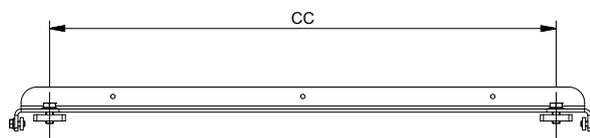
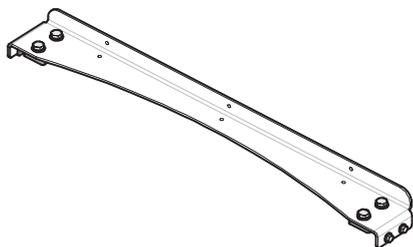

INFORMATION

Used in pairs as spacers between the profiles of twin crane bridges. The measure CC is the length between the two crane profiles centre-lines. **ATTENTION!** Sold individually.

#		CC	m [kg]	Note
30s				
741673	LHB	800	2.6	
741674	LHB	1000	3	
50s				
740525	PHB1	800	3.5	
743613	AHB140/190	800	4	
743614	AHB140/190	1000	4.8	
75s				
741671	AHB3	800	5.2	
741672	AHB3	1000	6	

SERVICE HATCHES

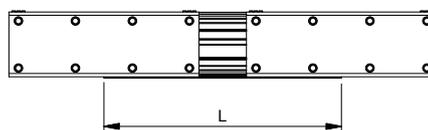
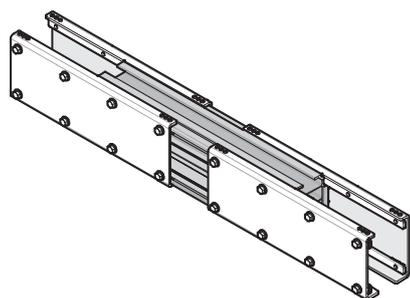

INFORMATION

Service hatches are used with long runways, and permit the introduction/removal of trolleys and accessories at the middle of the runway instead of from the ends.

At least one suspension must be mounted above the service hatch.

#		L	m [kg]	Note
50s				
743611	AHB140	500	17.5	
743612	AHB190	500	21.5	

TRAVEL LIMITER

(A)

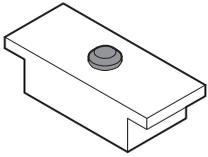

PHB, PHB1, AHB3

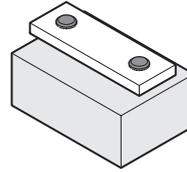

AHB140/190



INFORMATION
Mechanical stop. Are used for e.g. protecting cable trolleys from collisions.

#		L	m [kg]	Note
30s				
736834	PHB	20	0.1	
50s				
730354	PHB1	30	0.2	
743615	AHB140/190	60	0.2	
75s				
730465	AHB3	30	0.2	

(B)

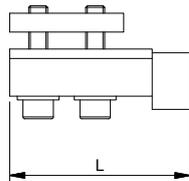
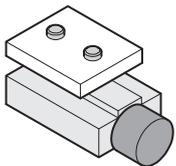

INFORMATION
Rubber bumper, may be fitted after commissioning.
ATTENTION! Cable trolleys cannot pass!

#		L	m [kg]	Note
30s				
730542		80	0.1	
50s				
730545		95	0.2	

(B) Double

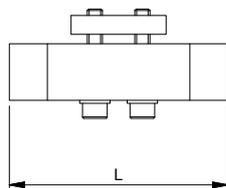
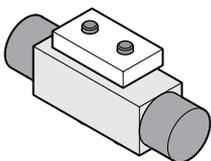

INFORMATION
Rubber bumper, may be fitted after commissioning.
ATTENTION! Cable trolleys cannot pass!

#		L	m [kg]	Note
30s				
742263		115	0.3	
50s				
737618		125	0.2	

(C)

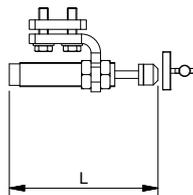
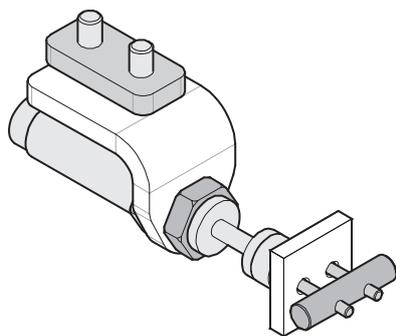

#	L [mm]	SL	E_{max}	E_{max}/h	v_{max}	F_{max}	m [kg]	Note
30s								
740220	152	25	80	60000	1	15000	1.1	
50s								
740217	157	25	80	60000	1	15000	1.2	
75s								
740218	157	25	80	60000	1	15000	1.2	

(D)

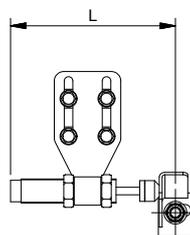
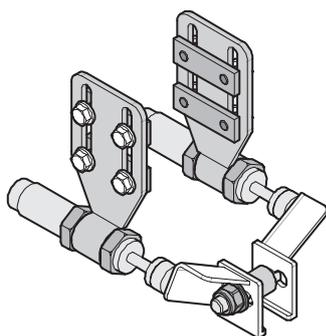

#	L [mm]	SL	E_{max}	E_{max}/h	v_{max}	F_{max}	m [kg]	Note
30s								
736603	LHB	174	25	160	120000	1	30000	1.7
50s								
743616	AHB140/190	174	25	160	120000	1	30000	1.3
75s								
736607		184	25	160	120000	1	30000	2.5

INFORMATION

Travel limiters (C) and (D) are hydraulically damped.
These are used for crane systems with large moving forces and in case there is a lot of operations at the end sections of the work area.

ATTENTION! Cable trolleys cannot pass (C)!

SL = stroke [mm]

E_{max} = maximum energy consumption per cycle [Nm]

E_{max}/h = maximum energy consumption per hour [Nm/h]

v_{max} = maximum impact velocity [m/s]

F_{max} = maximum impact force [N]

(E)

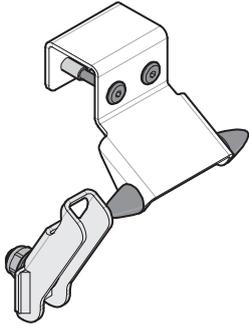

PHB

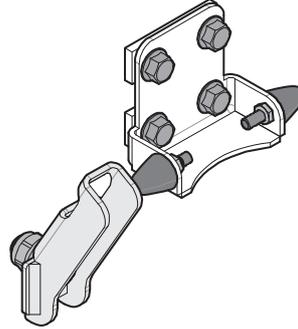
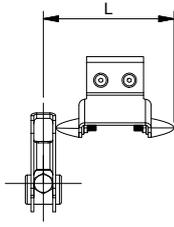

LHB

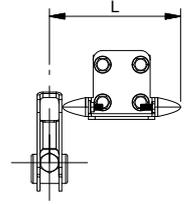

INFORMATION
 Mechanical stop. Are used for e.g. protecting cable trolleys from collisions.

#		L	m [kg]	Note
30s				
741692	PHB	115	0.3	Requires drilling in the profile
741684	LHB	125	0.8	

FRICTION ROLLERS

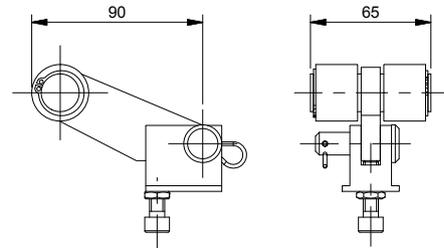
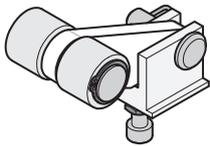

INFORMATION
 Used to prevent autonomous system movements.

#	m [kg]	Note
30s		
736176	0.5	
50s		
736176	0.5	
75s		
736177	0.5	

SPACER BRACE

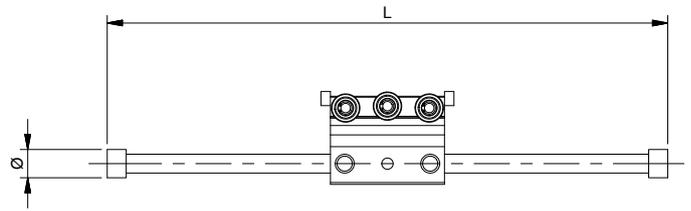
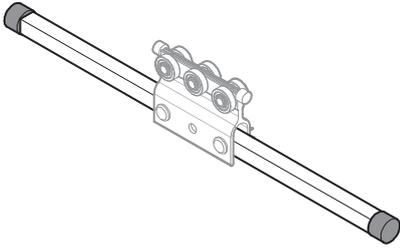

INFORMATION

Stand-alone unit to be fitted in a runway to maintain the separation of the bridges.
Trolley included.

#	L	Ø	m [kg]	Note
30s				
738200	600	40	1.2	
738203	1000	40	1.6	
50s				
738201	600	40	1.9	
738204	1000	40	2.3	
75s				
738202	600	50	3.9	
738205	1000	50	4.5	

PARKING BRAKES

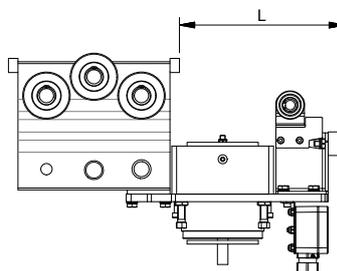
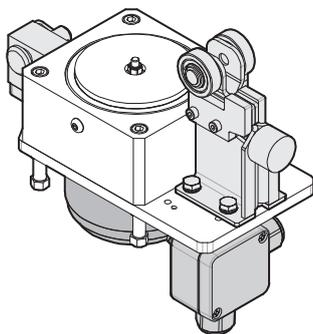
**INFORMATION**

The support wheel unit can be divided for fitting on a profile from below.

An inverted brake is spring-actuated when it is not energized.

A: Electric 230 V / 82 W

B: Inverted electric 230 V / 82 W

C: Pneumatic

D: Inverted pneumatic

E: Pneumatic with solenoid valve 24 VDC / 4.5 W

F: Inverted pneumatic with solenoid valve 24 VDC / 4.5 W

G: Pneumatic with solenoid valve 230 VAC / 9

R: Inverted pneumatic with solenoid valve 230 V / 9 W

ATTENTION! Electrical work is only permitted to be performed by a trained electrician.

#	Type	Brake force [N]	L [mm]	m [kg]	Note
30s					
743800	A	200	189	5.2	IP 54
743801	B	280	189	5.4	IP 54
743802	C	0 - 500	189	3.4	
743803	D	280	189	3.5	
743804	E	0 - 500	189	3.7	IP 65
743805	F	280	189	3.8	IP 65
743806	G	0 - 500	189	3.7	IP 65
743807	H	280	189	3.8	IP 65
50s					
743808	A	200	174	5.2	IP 54
743809	B	280	174	5.4	IP 54
743810	C	0 - 500	174	3.4	
743811	D	280	174	3.5	
743812	E	0 - 500	174	3.7	IP 65
743813	F	280	174	3.8	IP 65
743814	G	0 - 500	174	3.7	IP 65
743815	H	280	174	3.8	IP 65
75s					
743816	A	200	164	5.3	IP 54
743817	B	280	164	5.5	IP 54
743818	C	0 - 500	164	3.5	
743819	D	280	164	3.6	
743820	E	0 - 500	164	3.8	IP 65
743821	F	280	164	3.9	IP 65
743822	G	0 - 500	164	3.8	IP 65
743823	H	280	164	3.9	IP 65

SIGNS



#		Text	Max load/S.W.L	Dim.	Note
30s					
744008	PHB	Movomech		240 x 55	Sticker
744009	PHB	Max last	1 - 1000*	300 x 70	Sticker
744010	PHB	S.W.L.	1 - 1000*	300 x 70	Sticker
744000	LHB	Movomech		330 x 87	
744001	LHB	Movomech		635 x 87	
744002	LHB	Movomech + Max last	1 - 1000*	635 x 87	
744003	LHB	Movomech + S.W.L.	1 - 1000*	635 x 87	
50s					
744008	PHB1	Movomech		240 x 55	Sticker
744009	PHB1	Max last	1 - 1000*	300 x 70	Sticker
744010	PHB1	S.W.L.	1 - 1000*	300 x 70	Sticker
744004	AHB140/190	Movomech		300 x 87	
744005	AHB140/190	Movomech		635 x 87	
744006	AHB140/190	Movomech + Max last	1 - 1000*	635 x 87	
744007	AHB140/190	Movomech + S.W.L.	1 - 1000*	635 x 87	
75s					
744000		Movomech		330 x 87	
744001		Movomech		635 x 87	
744002		Movomech + Max last	1 - 1000*	635 x 87	
744003		Movomech + S.W.L.	1 - 1000*	635 x 87	
* to be stated when ordering					

FASTENERS AND TOOLS

Screws

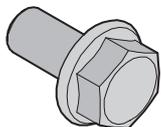

#	Note
730215	M8 x 10
730216	M8 x 12
730217	M8 x 14
730218	M8 x 16
730219	M8 x 20
730297	M8 x 40

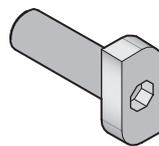

#	Note
730114	M8 x 17
730113	M8 x 24
732239	M8 x 35

Nuts



#	Note
730132	M4
730131	M5
730130	M6
730115	M8

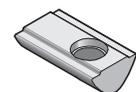

#	Note
744018	M4
744019	M5
744020	M6
734764	M8

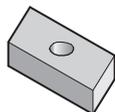

#	Note
730139	M4
730138	M5
730137	M6
730136	M8

#	CC / L [mm]	Note
730728	M6 30 / 40	
740500	M8 40 / 60	
730659	M8 80 / 100	
731379	M8 120 / 140	

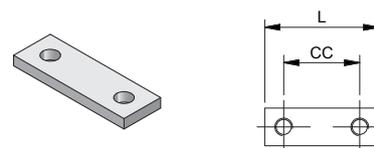

#	CC / L [mm]	Note
730214	M8 140 / 160	

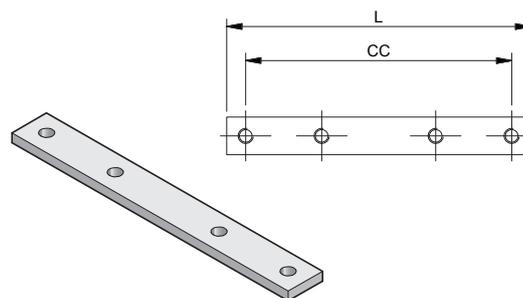

Drill guide tool

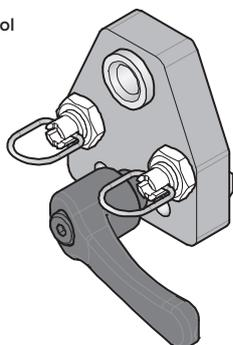

#	Note
744025	AHB140/190 Used when drilling holes for end stops

MEDIA SUPPLY

SPIRAL HOSE

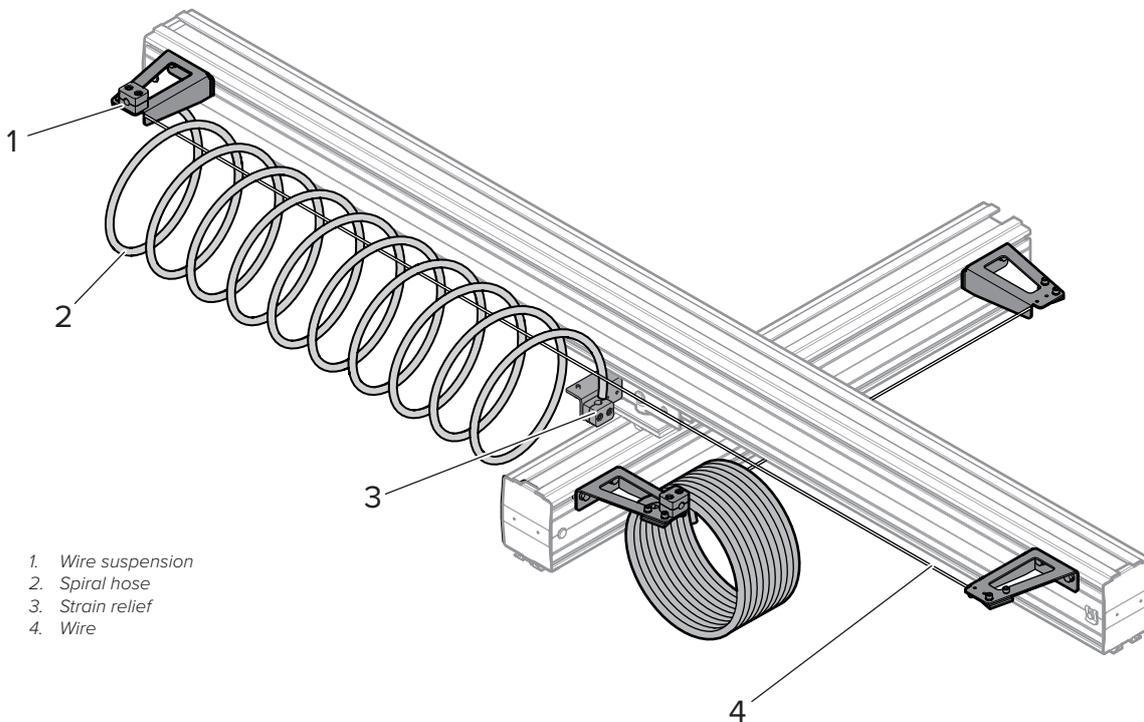

- 1. Wire suspension
- 2. Spiral hose
- 3. Strain relief
- 4. Wire

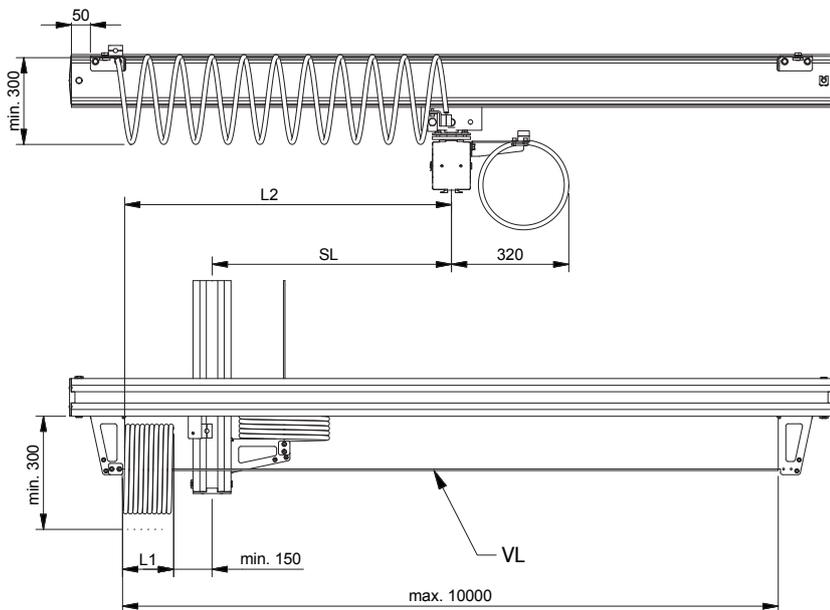

$SL = \text{stroke [m]}$
 $L1 = \text{hose compressed [m]}$
 $L2 = \text{hose extended [m]}$
 $VL = \text{wire length [m]}$

$L2 = (1.05 \times SL) + 0.15$
 $L1 = SL / 20$
 $VL = L2 + 0.3$

Sample calculation for SL = 8 m:
 $L2 = (1.05 \times 8) + 0.15 \quad 8.55 \text{ m}$
 $L1 = 8 / 20 \quad 0.4 \text{ m}$
 $VL = 8.55 + 0.3 \quad 8.85 \text{ m}$

Wire suspension

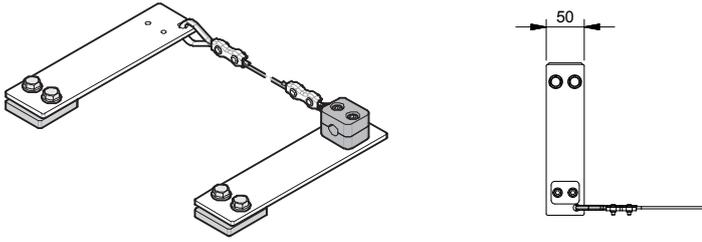

PHB, PHB1

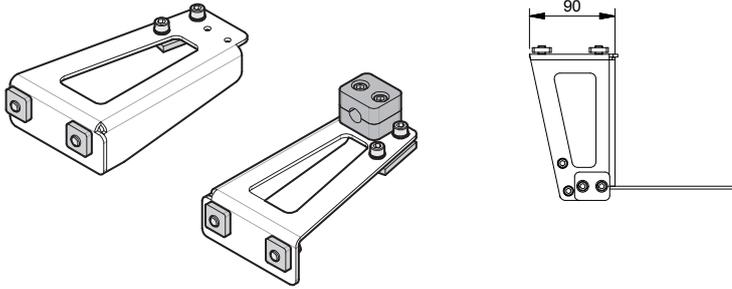

LHB, AHB140/190, AHB3

#		m [kg]	Note
30s			
742169	PHB	1.1	
743646	LHB	0.9	
50s			
738226	PHB1	1.1	
743645	AHB140/190	0.9	
75s			
743645	AHB3	0.9	

Spiral hose

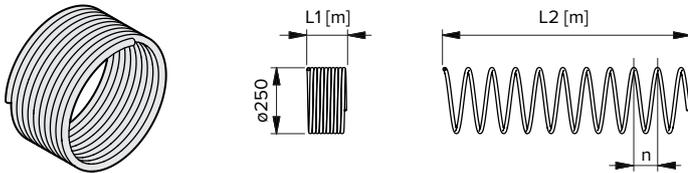

#	Ø	Note
741151	12 x 10	

Strain relief

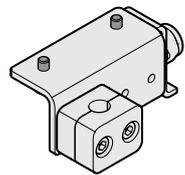

#	Note
739976	

Cable ties



#	[mm]	Note
732509	145 x 25	

Hose joints

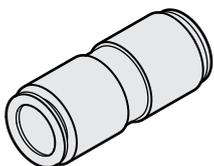

#	Note
741168	

Wire

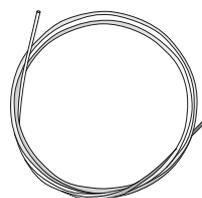

#	Ø	Note
730693	3	

CABLE TROLLEY FOR TRACK PROFILE

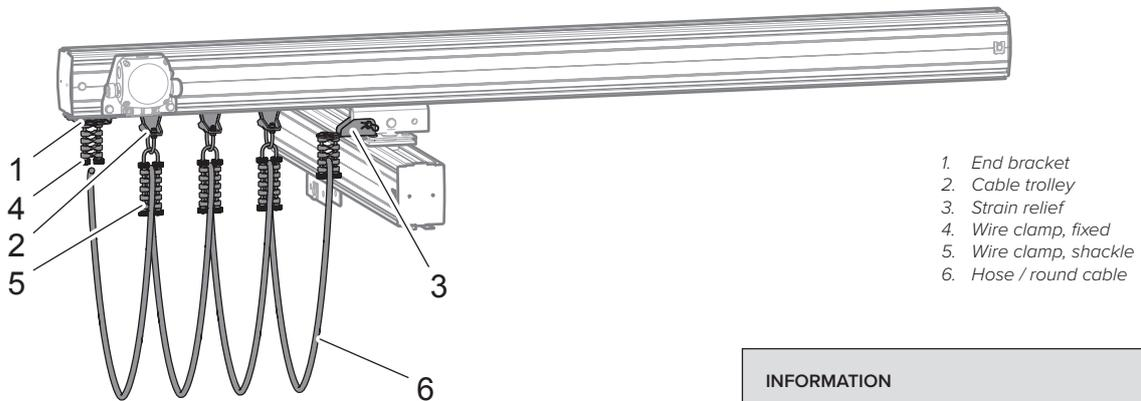

INFORMATION

Cable trolleys should have travel limiters to prevent the crane system trolley colliding with the cable trolleys and creating unnecessary wear.

Cables and hoses are available by the meter.

There are four types of cable trolleys:

- (A) flat cable saddle, maximum width 15 mm
- (B) ball joint for hose and / or round cable Ø10 - 36 mm
- (C) strap for vacuum hose, max Ø90 mm
- (D) shackle for hose and / or round cable Ø8 - 22 mm

Wire clamps for (B) can rotate 360° in end fittings, cable trolleys and strain reliefs.

Wire clamps for (D) cannot rotate in end fittings and strain reliefs and is limited to 90° in cable trolleys which has the advantage of neither hose nor cable twisting.

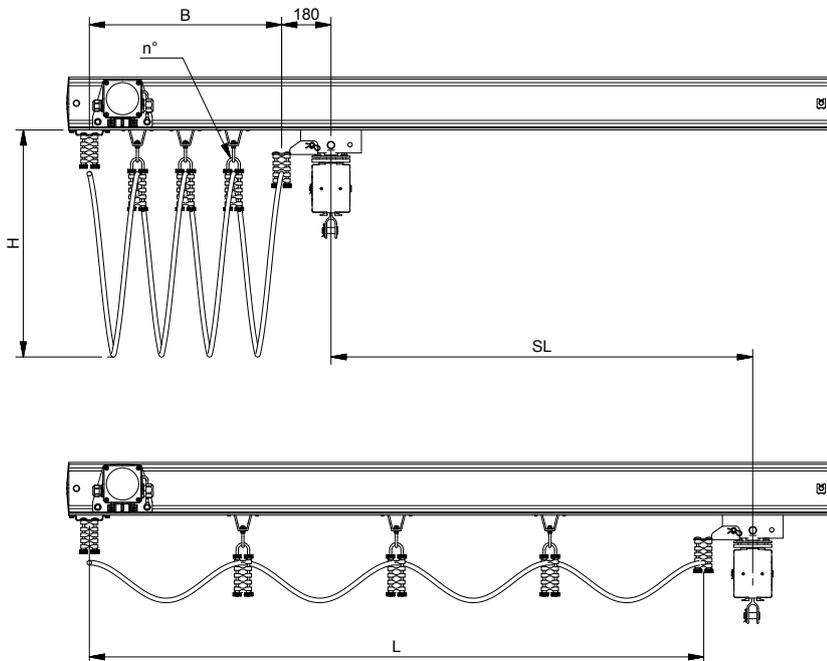

SL = stroke [m]

B = buffer [m]

L = minimum length of cable/hose [m]

H = pendant [m]

n° = number of cable trolleys

$$L = SL_{max} \times 1.2$$

$$n^\circ = (L / 2H) - 1$$

$$B_{min} = (n^\circ + 1) \times 0.1$$

$$H_{max} = 0.6$$

Sample calculation for $SL = 12$ m, $H = 0.4$ m:

$$L2 = 12 \times 1.2 \quad 14.4 \text{ m}$$

$$n^\circ = (14.4 / 0.8) - 1 \quad \text{qty } 17$$

$$B = (17 + 1) \times 0.1 \quad 1.8 \text{ m}$$

(A) Saddle

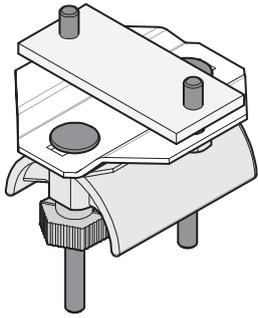

End bracket

#	Note
30s	
730485	End bracket
50s	
730488	End bracket
75s	
730488	End bracket

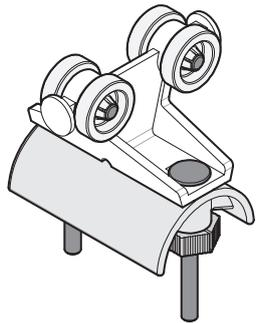

Cable trolley

#	Max load [kg]	Note
30s		
730467	Cable trolley	6.3
50s		
730470	Cable trolley	10
75s		
730470	Cable trolley	10

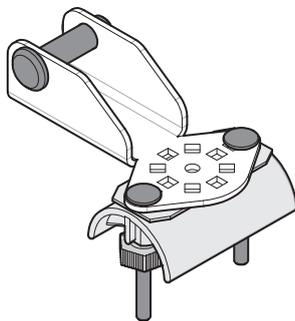

Strain relief

#	Note
30s	
743660	Strain relief
50s	
743660	Strain relief
75s	
743683	Strain relief



Flat cable

#	[mm]	m [kg/m]	Note
730648	4G1.5 15 x 5	0.14	
730649	5G1.5 18 x 5	0.19	

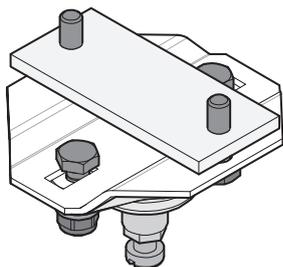
(B) Ball joint

End bracket

#	Note
30s	
730491	End bracket
50s	
730492	End bracket
75s	
730492	End bracket

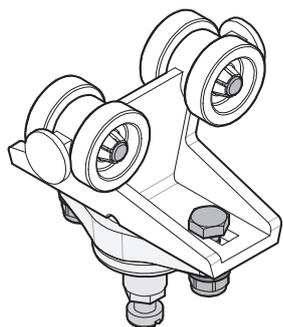

Cable trolley

#	Max load [kg]	Note
30s		
730469	Cable trolley	6.3
50s		
730472	Cable trolley	10
75s		
730472	Cable trolley	10

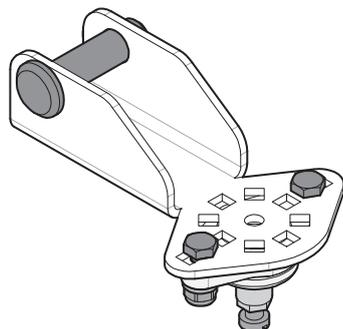

Strain relief

#	Note
30s	
743688	Strain relief
50s	
743688	Strain relief
75s	
743689	Strain relief

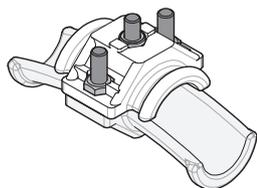

Wire clamp for cable / hose Ø10 - 36 mm

#	Note
730473	Ø10 - 16 mm
730474	Cable clamp Ø17 - 25 mm
730475	Ø26 - 36 mm

INFORMATION

If different sizes of cable clamps are used, the largest must be mounted closest to the trolley.



Round cable

#		Ø	m [kg/m]	Note
730650	3G1.5	10	0.14	
730652	5G1.5	12	0.19	



Pneumatic hose

#		Ø	m [kg/m]	Note
730646	PVC	15.5 x 10	0.14	Standard
743104	PUR	12 x 8	0.08	Extra flexible

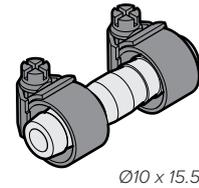
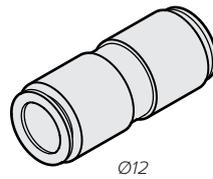

Hose joints

#	Ø	Note
741168	12	For PUR hose
730680	10 x 15.5	

(C) Strap



End bracket

#	Note
30s	
730494	End bracket
50s	
730496	End bracket
75s	
730496	End bracket



Cable trolley

#	Max load [kg]	Note
30s		
730497	Cable trolley	6.3
50s		
730498	Cable trolley	10
75s		
730498	Cable trolley	10



Strain relief

#	Note
30s	
743639	Strain relief
50s	
743639	Strain relief
75s	
743684	Strain relief

(D) Shackle

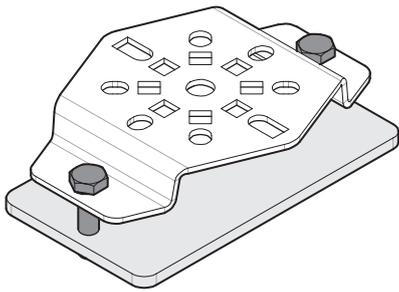

End bracket

#	Note	
30s		
743661	End bracket	For cable clamp, fixed
50s		
743640	End bracket	For cable clamp, fixed
75s		
743640	End bracket	For cable clamp, fixed

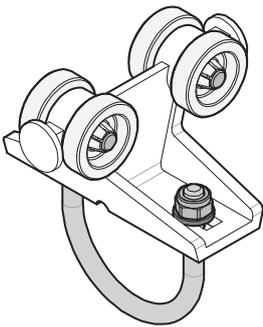

Cable trolley

#		Max load [kg]	Note
30s			
743065	Cable trolley	6,3	For cable clamp, shackle
50s			
743066	Cable trolley	10	For cable clamp, shackle
75s			
743066	Cable trolley	10	For cable clamp, shackle

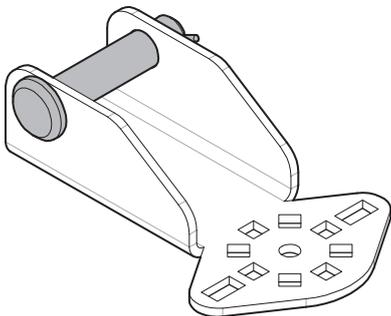

Strain relief

#	Note	
30s		
743641	Strain relief	For cable clamp, fixed
50s		
743641	Strain relief	For cable clamp, fixed
75s		
743682	Strain relief	For cable clamp, fixed

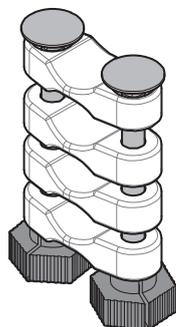

Cable clamp, fixed, for cable Ø8 - 22 mm

#	Note	
743642	2 x Ø8-22, fixed	
743643	Cable clamp	3 x Ø8-22, fixed
743644	4 x Ø8-22, fixed	

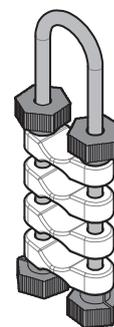

Cable clamp, shackle, for cable Ø8 - 22 mm

#	Note	
743060	2 x Ø8-22, shackle	
743061	Cable clamp	3 x Ø8-22, shackle
743062	4 x Ø8-22, shackle	



Round cable

#		Ø	m [kg/m]	Note
730650	3G1.5	10	0.14	
730652	5G1.5	12	0.19	



Pneumatic hose

#		Ø	m [kg/m]	Note
730646	PVC	15.5 x 10	0.14	Standard
743104	PUR	12 x 8	0.08	Extra flexible

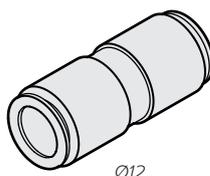

Ø12

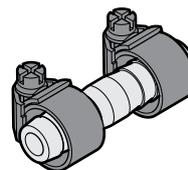

Ø10 x 15.5

Hose joints

#	Ø	Note
741168	12	For PUR hose
730680	10 x 15.5	

CABLE TROLLEY FOR C-RAIL

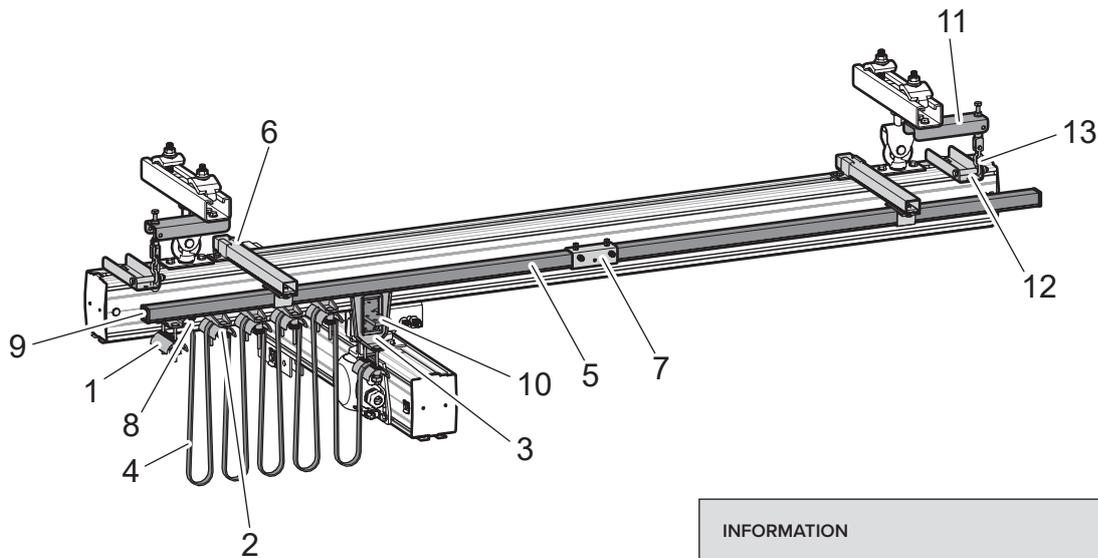

1. End bracket
2. Cable trolley
3. Follower trolley
4. Cable / hose
5. C-rail
6. Bracket
7. Splicing kit with lock screws
8. End stop
9. End cover
10. Follower arm
11. Cable trough support - upper
12. Cable trough support - lower
13. Chain

INFORMATION

Cable trolleys should have travel limiters to prevent the crane system trolley colliding with the cable trolleys and creating unnecessary wear.

Cables and hoses are available by the meter.

There are four types of cable trolleys:

- (A) flat cable saddle, maximum width 15 mm
- (B) ball joint for hose and / or round cable Ø10 - 36 mm
- (C) strap for vacuum hose, max Ø90 mm
- (D) shackle for hose and / or round cable Ø8 - 22 mm

Wire clamps for (B) can rotate 360° in end fittings, cable trolleys and strain reliefs.

Wire clamps for (D) cannot rotate in end fittings and strain reliefs and is limited to 90° in cable trolleys which has the advantage of neither hose nor cable twisting.

Cable trolley for C-rail is only applicable for 50s and 75s.

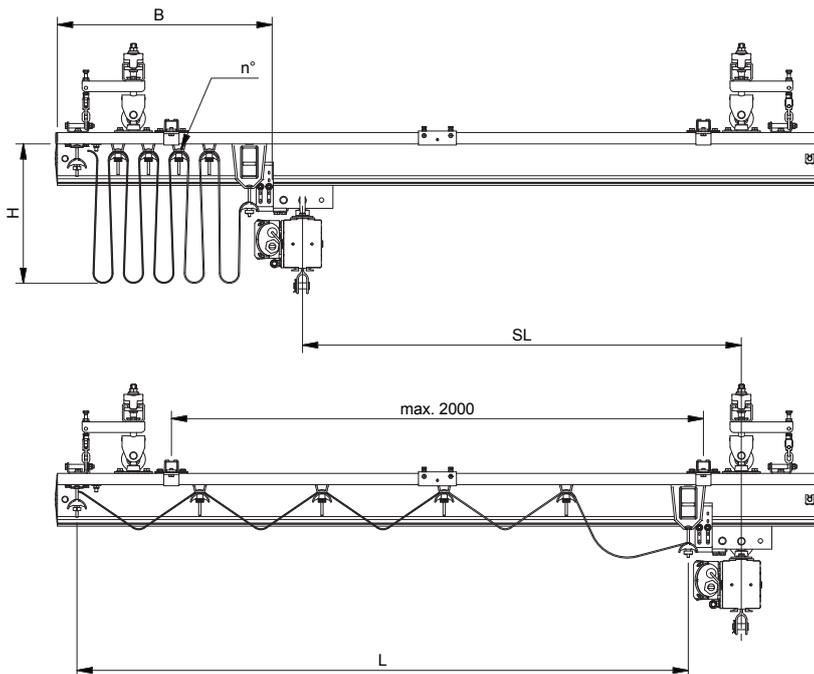

- $SL = \text{stroke [m]}$
- $B = \text{buffer [m]}$
- $L = \text{minimum length of cable/hose [m]}$
- $H = \text{pendant [m]}$
- $n^\circ = \text{number of cable trolleys}$

$$L = SL_{max} \times 1.2$$

$$n^\circ = (L / 2H) - 1$$

$$B_{min} = (n^\circ + 1) \times 0.1$$

$$H_{max} = 0.6$$

Sample calculation for $SL = 12 \text{ m}$, $H = 0.4 \text{ m}$:

$L2 = 12 \times 1.2$	14.4 m
$n^\circ = (14.4 / 0.8) - 1$	qty 17
$B = (17 + 1) \times 0.1$	1.8 m

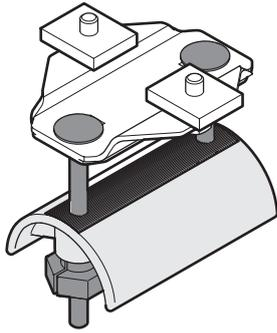
(A) Saddle*End bracket*

#	Note
743856	End bracket

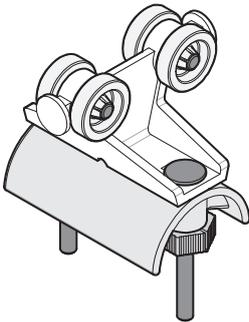
*Cable trolley*

#	Note
730467	Cable trolley

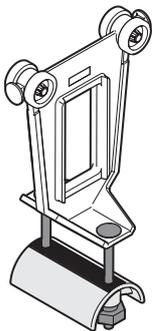
*Follower trolley*

#	Note
743857	Follower trolley

*Flat cable*

#		[mm]	m [kg/m]	Note
730648	4G1.5	15 x 5	0.14	
730649	5G1.5	18 x 5	0.19	

(B) Ball joint

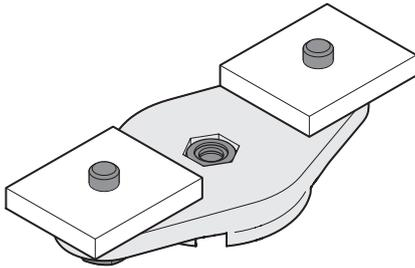

End bracket

#	Note
743858	End bracket

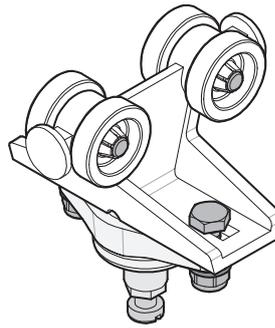

Cable trolley

#	Note
730469	Cable trolley

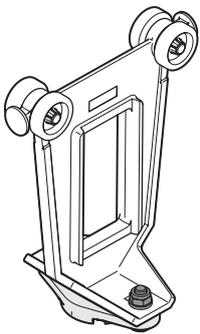

Follower trolley

#	Note
743859	Follower trolley

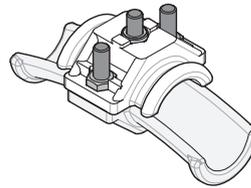

Wire clamp for cable/hose Ø10 - 36 mm

INFORMATION
If different sizes of cable clamps are used, the largest must be mounted closest to the trolley.

#	Note
730473	Ø10 - 16 mm
730474	Cable clamp Ø17 - 25 mm
730475	Ø26 - 36 mm



Round cable

#	Ø	m [kg/m]	Note
730650	3G1.5	10	0.14
730652	5G1.5	12	0.19



Pneumatic hose

#	Ø	m [kg/m]	Note
730646	PVC 15.5 x 10	0.14	Standard
743104	PUR 12 x 8	0.08	Extra flexible

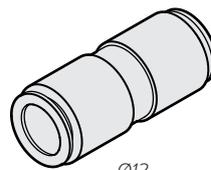

Ø12

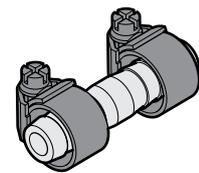

Ø10 x 15.5

Hose joints

#	Ø	Note
741168	12	For PUR hose
730680	10 x 15.5	

(C) Strap



End bracket

#	Note
743860	End bracket

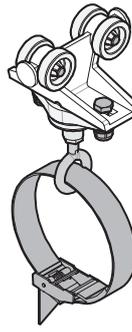

Cable trolley

#	Note
730497	Cable trolley



Follower trolley

#	Note
743861	Follower trolley

(D) Shackle

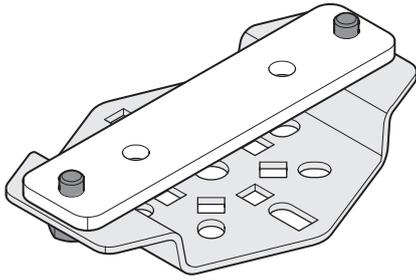

End bracket

#	Note
743862	End bracket For cable clamp, fixed

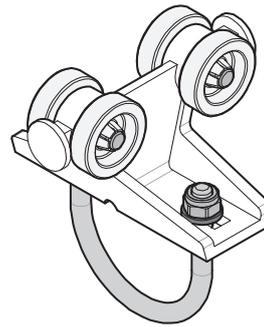

Cable trolley

#	Note
743065	Cable trolley For cable clamp, shackle

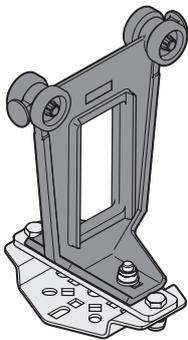

Follower trolley

#	Note
743863	Follower trolley For cable clamp, fixed

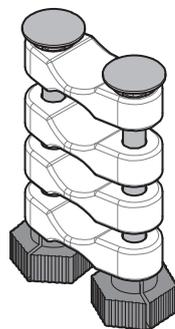

Cable clamp, fixed, for cable Ø8 - 22 mm

#	Note
743642	2 x Ø8-22, fixed
743643	Cable clamp 3 x Ø8-22, fixed
743644	4 x Ø8-22, fixed

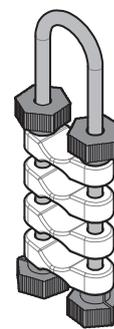

Cable clamp, shackle, for cable Ø8 - 22 mm

#	Note
743060	2 x Ø8-22, shackle
743061	Cable clamp 3 x Ø8-22, shackle
743062	4 x Ø8-22, shackle



Round cable

#		Ø	m [kg/m]	Note
730650	3G1.5	10	0.14	
730652	5G1.5	12	0.19	



Pneumatic hose

#		Ø	m [kg/m]	Note
730646	PVC	15.5 x 10	0.14	Standard
743104	PUR	12 x 8	0.08	Extra flexible

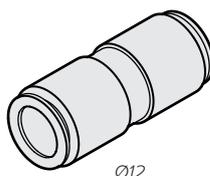

Ø12

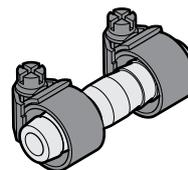

Ø10 x 15.5

Hose joints

#	Ø	Note
741168	12	For PUR hose
730680	10 x 15.5	

C-rail

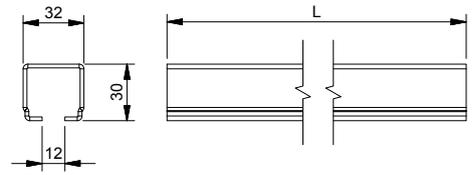
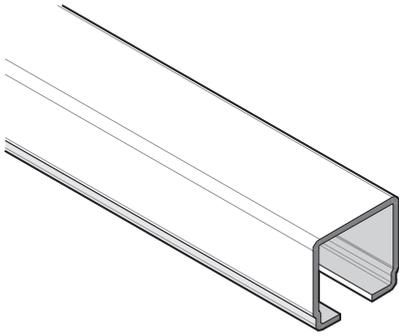

#	L [m]	m [kg/m]	Note
733651	4	0.2	
732572	6	0.2	

Mounting bracket

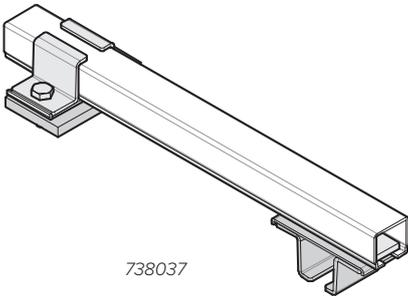

738037

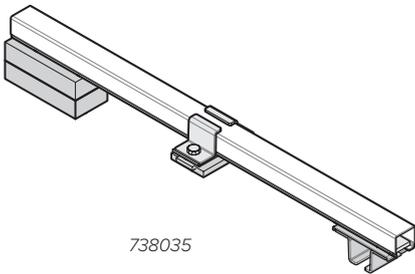
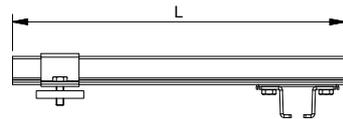

738035

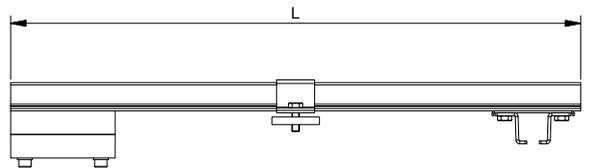

#	L [mm]	m [kg]	Note
738037	350	0.2	
738035	600	0.4	For flexibly suspended bridge

Joint

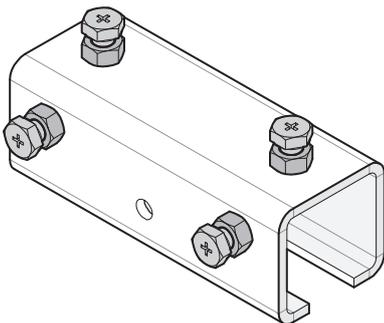

#	Note
732574	

End stop

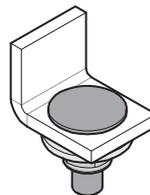

#	Note
732575	

End cover

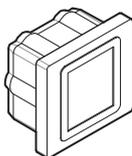

#	Note
732576	

Follower arm

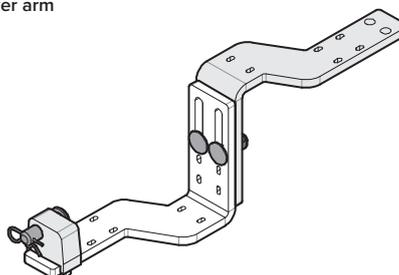

#	m [kg]	Note
743864	1.6	

Cable tray support - upper

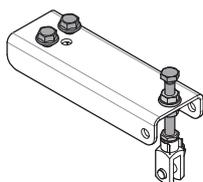

#	m [kg]	Note
743671	0.5	1x / suspension

Cable tray support - lower

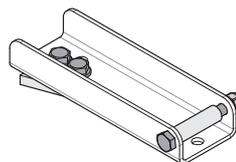

#	m [kg]	Note
743672	0.5	1x / suspension

Support chain

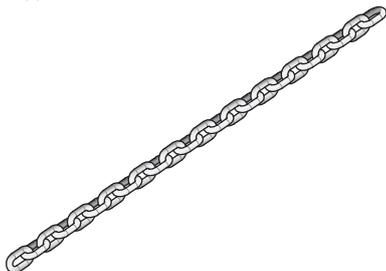

#	Z [mm]	m [kg/m]	Note
743673	183 - 2000*	0,8	

* to be stated when ordering

CABLE CHAIN

1. Grounding cable
2. Trough
3. Trough with slide strip
4. Trough bracket
5. Earth plate
6. Cable chain
7. Fitting
8. Cable trough support - upper
9. Cable trough support - lower
10. Chain
11. Follower arm

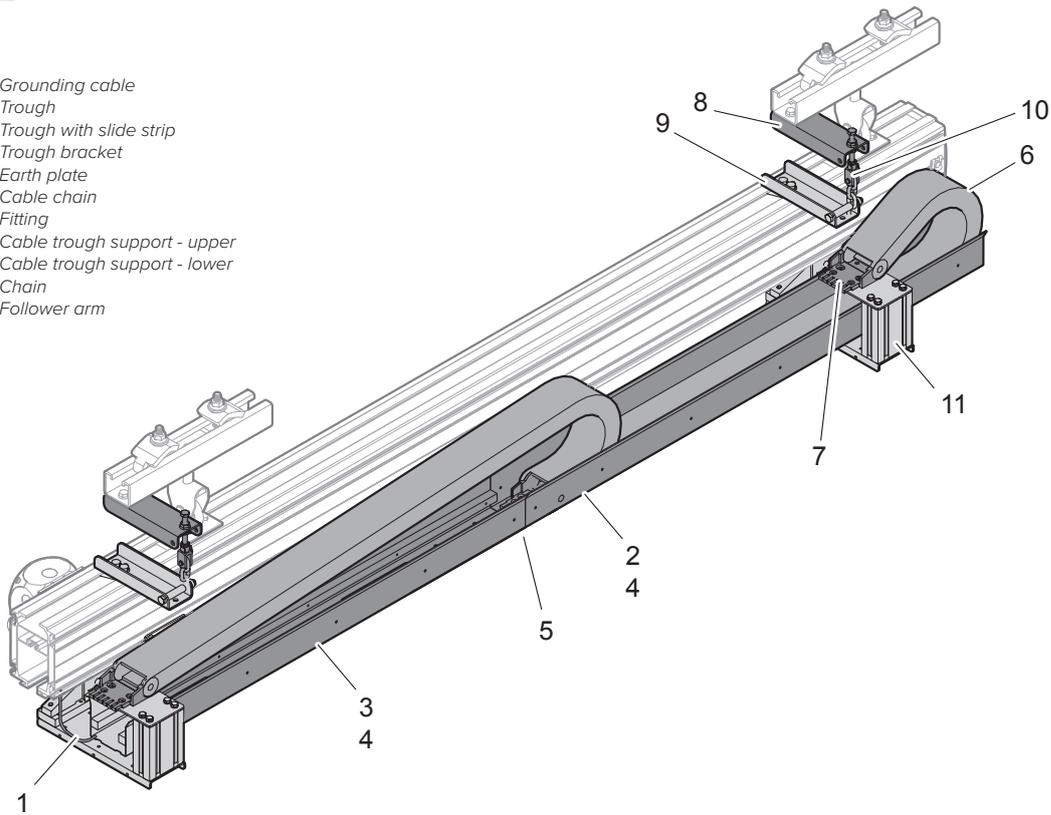

INFORMATION

Fits only AHB 140 / 190.

A grounding cable is used for earthing and the equalization of potentials between crane / tracks, or between crane / track and earthed component.

If the connection is painted or coated in any way, the coating must be removed to create a satisfactory connection.

In case of $SL > 4$ m, half of the troughs must be fitted with slide strips.

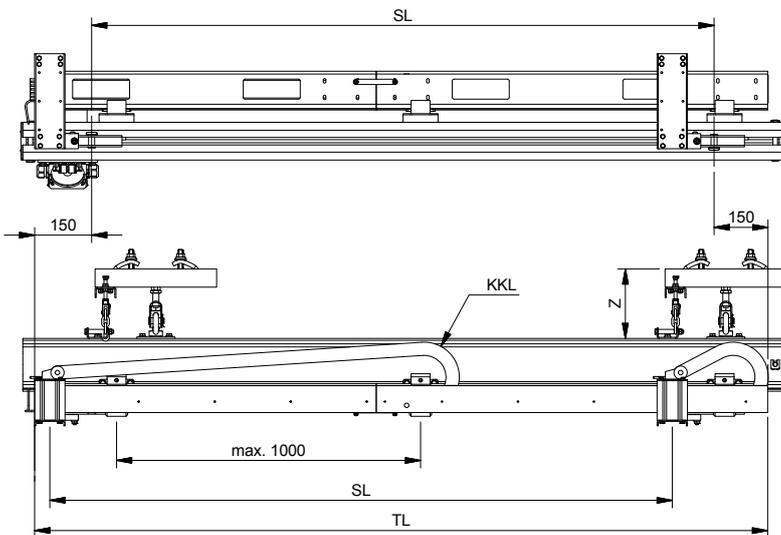

SL = stroke [m]
 TL = trough length [m]
 KKL = cable chain length [m]

$$TL = SL + 0.3$$

$$KKL = (SL / 2) + 0.5$$

Sample calculation for $SL = 4$ m:

$$TL = 4 + 0.3 \quad 4.3 \text{ m}$$

$$KKL = (4 / 2) + 0.5 \quad 2.5 \text{ m}$$

Tray

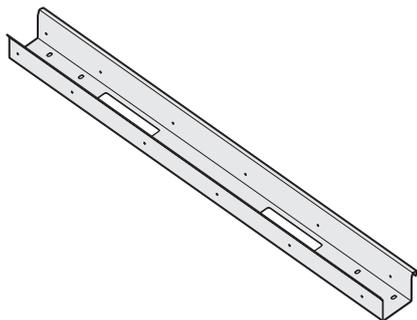

#	L [m]	m [kg]	Note
743666	2	5.4	

Tray with slide strip

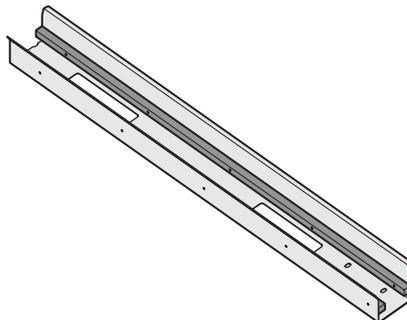

#	L [m]	m [kg]	Note
743667	2	5.4	

Tray bracket

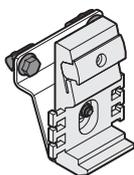

#	m [kg]	Note
743665	0.3	2x / trough

Ground plate

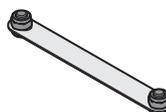

#	Note
743668	1x / trough

Cable chain

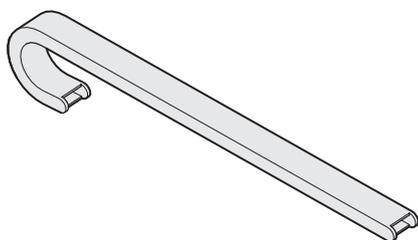

#	m [kg/m]	Note
743669	0.91	Radius = 75 mm. 25 x 57 mm internal

End brackets

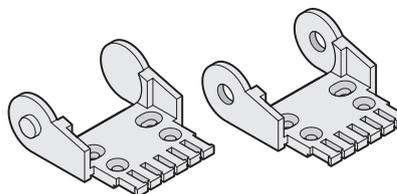

#	m [kg]	Note
743670	0.1	

Cable tray support - upper

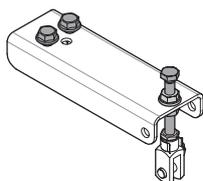

#	m [kg]	Note
743671	0.5	1x / suspension

Cable tray support - lower

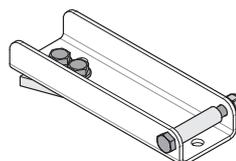

#	m [kg]	Note
743672	0.5	1x / suspension

Grounding cable

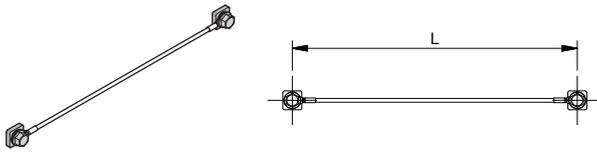

#	L [m]	Note
730692	0.3	

Support chain

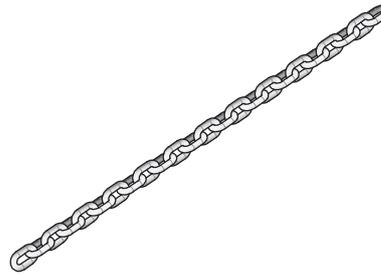

#	Z [mm]	m [kg/m]	Note
743673	183 - 2000*	0,8	
* to be stated when ordering			

Follower arm

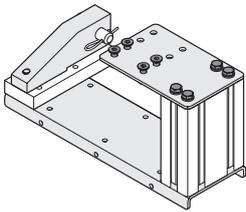

#	m [kg]	Note
743674	1.6	



Round cable

#	Ø	m [kg/m]	Note
732811	4G0.5	7	0.06 Extra flexible
732814	3G1.5	8	0.1 Extra flexible
731513	5G1.5	9	0.14 Extra flexible



Pneumatic hose

#	Ø	m [kg/m]	Note
743104	PUR 12 x 8	0.08	Extra flexible

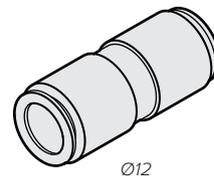

Hose joints

#	Ø	Note
741168	12	For PUR hose

POWER RAIL

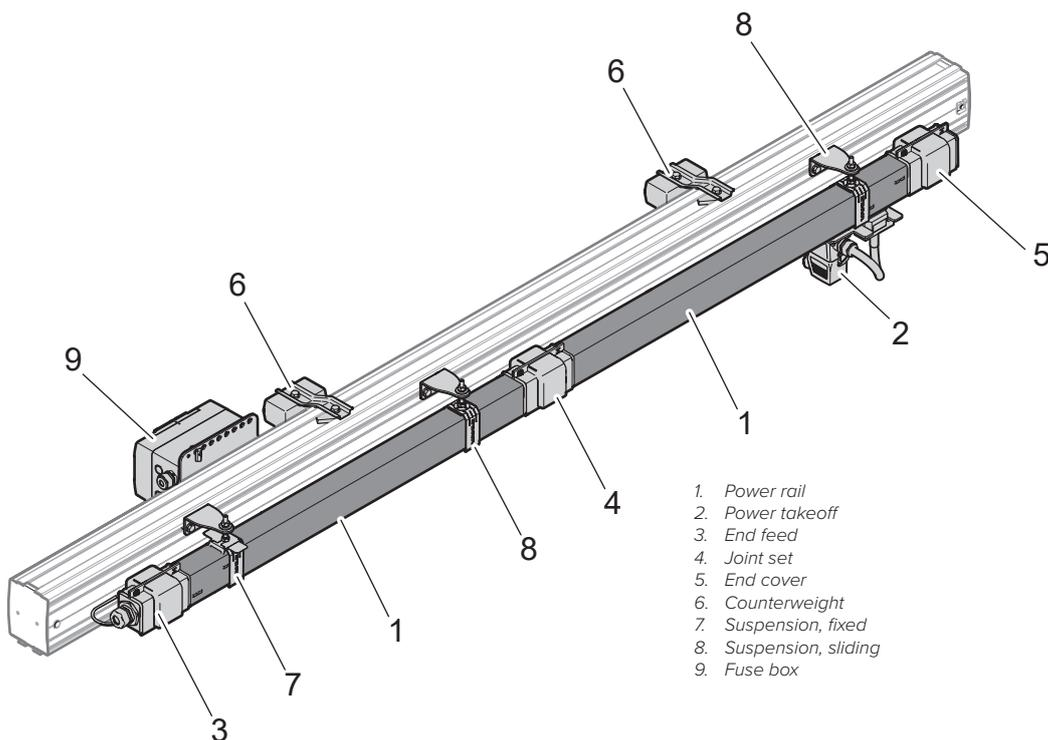

INFORMATION

The end feed must have a fixed suspension, the rest must be sliding. Each bridge must have its own fuse box if the bridge is supplied with power from a conductor rail in the track. A counterweight is used to prevent the rail from hanging askew.

ATTENTION! Electrical work is only permitted to be performed by a trained electrician.

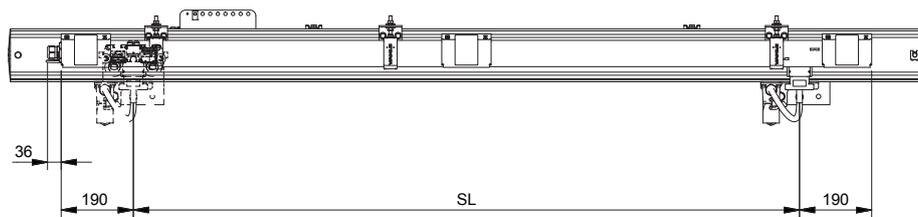

$SL = \text{stroke [m]}$
 $L = \text{power rail length [m]}$
 $L_{\text{tot}} = \text{power rail total length [m]}$

$L_{\text{tot}} = SL + 0.2$

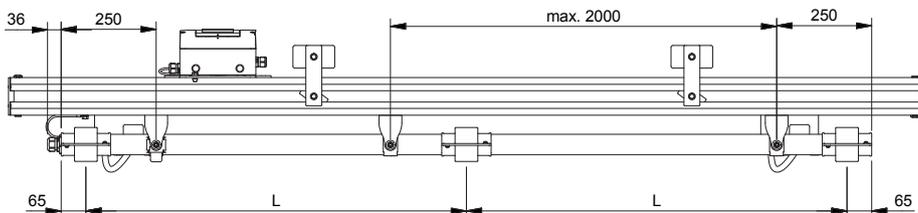

Sample calculation for $SL = 5 \text{ m}$:
 $L_{\text{tot}} = 5 + 0.2 \quad 5.2 \text{ m}$

Power rail

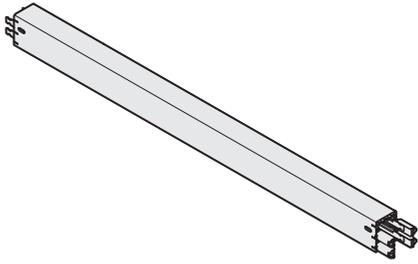

#	L [m]	m [kg]	Note
743015	1	1.7	
742306	3	4.9	
742307	4	6.5	

Power takeoff

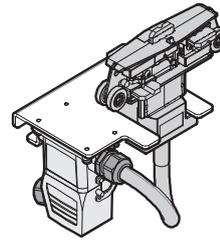

#	m [kg]	Note
742980	1.8	

End feed

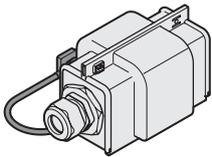

#	m [kg]	Note
742312	0.3	

Joint set

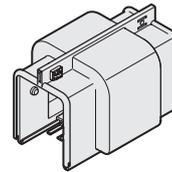

#	m [kg]	Note
742308	0.1	

End cover

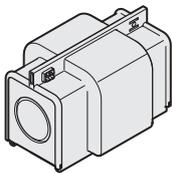

#	m [kg]	Note
742311	0.1	

Counterweight

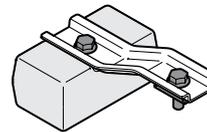

#	m [kg]	Note
743870	2.3	1x / m power rail

Suspensions for power rail

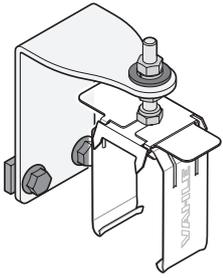

LHB, AHB3

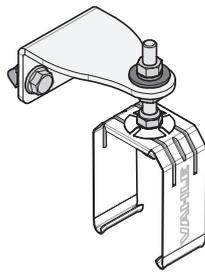

AHB140/190

#		m [kg]	Note
30s			
742978	LHB	0.4	Fixed
742979	LHB	0.4	Sliding
50s			
743675	AHB140/190	0.2	Fixed
743676	AHB140/190	0.2	Sliding
75s			
742978	AHB3	0.4	Fixed
742979	AHB3	0.4	Sliding

Fuse boxes

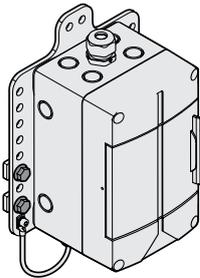

#		I [A]	m [kg]	Note
30s				
743078	LHB	1 × 10	3.1	
743079	LHB	3 × 10	3.1	
50s				
743686	AHB140/190	1 × 10	3.1	
743687	AHB140/190	3 × 10	3.1	
75s				
743078	AHB3	1 × 10	3.1	
743079	AHB3	3 × 10	3.1	

AIR PREPARATION UNITS

Air preparation units

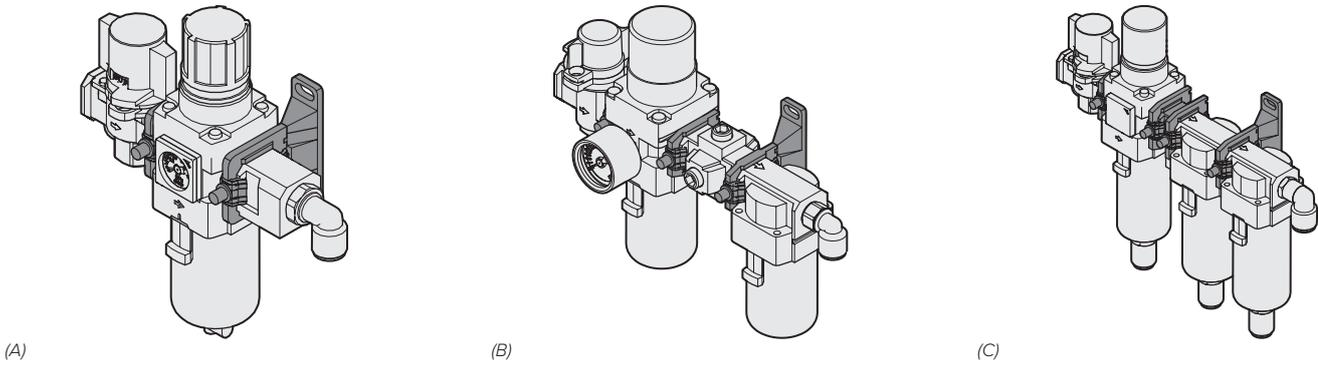

#	Type	[μ]	p _{max} [bar]	[l _n /min]	t [°C]	Note
735349	A	5	10	1700	5 - 60	
735350	B	0.3	10	350	5 - 60	
743057	C	0.01	10	240	5 - 60	

INFORMATION

A: blowdown valve, pressure regulator with manometer and filter (manual purging)

B: blowdown valve, pressure regulator with manometer and filter (manual purging), pneumatic unit (4 outlets), microfilter.

C: blowdown valve, pressure regulator with manometer and filter [manual purging], pneumatic unit (1 outlets), microfilter, sub-microfilter.
Used for sensitive applications, e.g. for air quality

All pneumatic units are supplied with Ø12 mm outlet connectors.

Filter

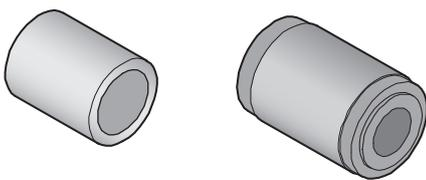

730671, 735351

742427

#	[μ]	Note
730671	5	
735351	0.3	
742427	0.01	

Mounting plates

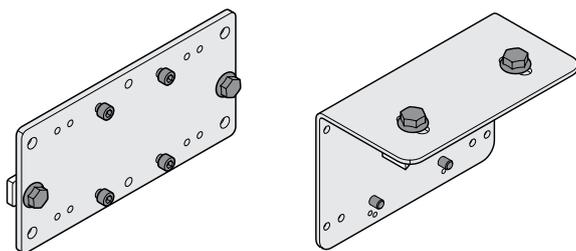

LHB, AHB140/190, AHB3

PHB1

#	m [kg]	Note
30s		
736168	LHB	
50s		
740831	PHB1	
736168	AHB140/190	
75s		
736168	AHB3	

LIMIT SWITCHES

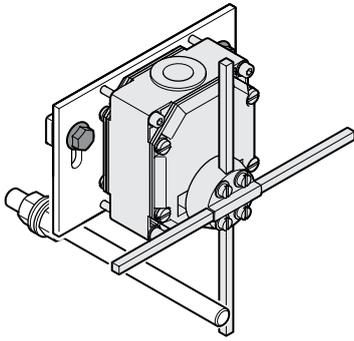

(A)

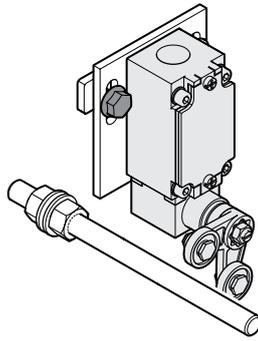

(C)

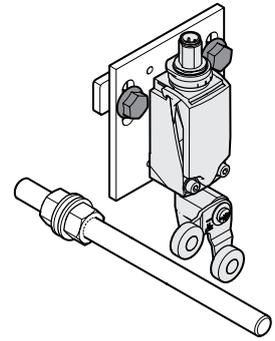

(D)

INFORMATION

A: 2 closing + 2 opening, switch with instantaneous switching.

B: 1 closing + 1 opening, switch with instantaneous switching.

D: 1 closing + 1 opening, switch with instantaneous switching.

ATTENTION! Electrical work is only permitted to be performed by a trained electrician.

#	Type	m [kg]	Note
30s			
730657	A	1	IP 54, PG13,5
730656	LHB	0.6	IP 66, PG13,5
743680	D	0.5	IP 66, M12 4-pin
50s			
742413	A	1	IP 54, PG13,5
742414	PHB1	1	IP 66, PG13,5
743681	D	1	IP 66, M12 4-pin
743677	A	1	IP 54, PG13,5
743678	AHB140/190	0.6	IP 66, PG13,5
743679	D	0.5	IP 66, M12 4-pin
75s			
730657	A	1	IP 54, PG13,5
730656	AHB3	0.6	IP 66, PG13,5
743680	D	0.5	IP 66, M12 4-pin

CONNECTION UNITS

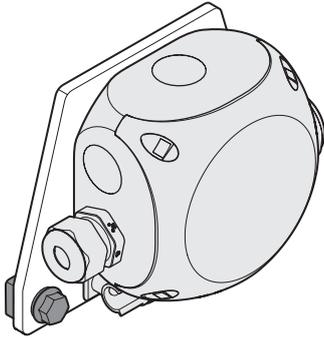

(A)

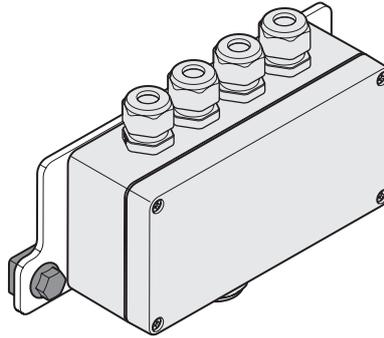

(D)

INFORMATION

A connection unit (A) must be used at the power supply end of the track system and for each bridge when using electric equipment. Threaded coupling suitable for both Ø8 - 17 mm round and 15 - 18 x 5 mm flat cables.

Connection unit (D) used for e.g. limit switch:

- 4 x M16 threaded coupling, cable Ø5 - 10 mm
- 1 x M20 threaded coupling, cable Ø10 - 14 mm
- Terminal block for 1.5 mm² wire included.

ATTENTION! Electrical work is only permitted to be performed by a trained electrician.

#	Type	m [kg]	Note
30s			
744017	LHB A	1	IP66, max 10 A
742268	LHB D	1.2	IP66, max 10 A
50s			
744016	PHB1 A	1	IP66, max 10 A
744017	AHB140/190 A	1	IP66, max 10 A
743656	AHB140/190 D		IP66, max 10 A
75s			
744017	AHB3 A	1	IP66, max 10 A
742268	AHB3 D	1.2	IP66, max 10 A

WORLD-CLASS LIFTING SOLUTIONS



Movomech AB Phone: +46 (0)44 28 29 00
www.movomech.com